

Genetic

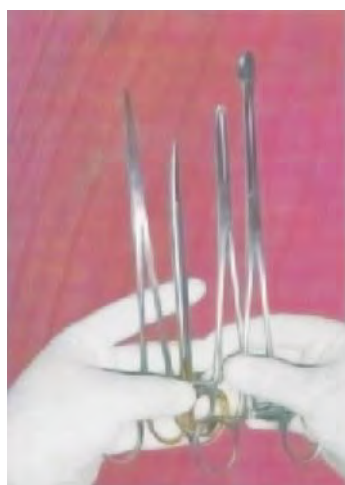

GENERAL SURGERY INSTRUMENTS

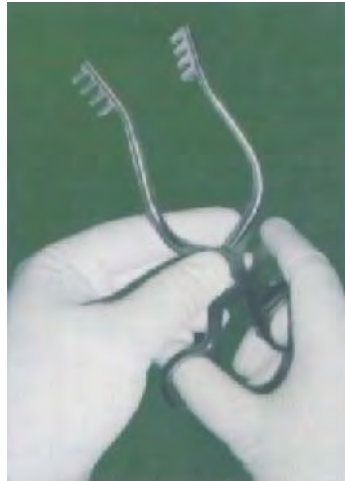

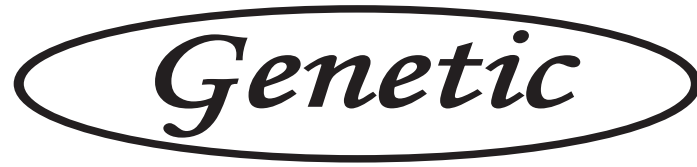

GENETIC INSTRUMENTS PVT LTD

Admin & Warehouse

Plot No.2, Sri Krishna Nagar,
3rd Street, Kolathur, Chennai - 600 099.
Ph: +91-44-26511506, 26511706, 26511806
e-mail: genetic@geneticinstruments.com

Factory & Registered Office

No.550/7, Poonamallee High Road,
Arumbakkam, Chennai – 600 106.

Genetic

GENETIC INSTRUMENTS PVT LTD, manufactures and market, **Surgical Instruments** of Highest Standard and Quality for all Specialties like General Surgery, Gynecology, Surgical Gastro/Oncology, Orthopedic/Spine, Neuro Surgery, Urology, and Cardio Vascular and Thoracic Surgery.



Also, we Manufacture Special Self Retaining TABLE MOUNTED RETRACTORS for Liver Transplant Surgery & Multiple Organ Transplant Surgery such as;

- Thompson Type Retractor for Liver Transplant Surgery.
- Omni tract Type Retractor for General Surgery / Urology.
- Book Walter Type Retractor for Obg / General Surgery.
- Mayfield Skull Clamp & Leyla Brain Retractor.



Few Key points of our Organization are:

- Direct sales Representation of Products and Services, in every part of Southern India.
- Specialized Marketing field staff, well supported by a marketing and customer service team.
- Continuous training programs for all staff members.



GENETIC is located in Chennai with its corporate office and Factory.

"Genetic" brand name stands for Superior Surgical Instruments. Every instrument fabricated with "Genetic" name is backed by more than two decades of expertise.

We continue to control our own instrument specifications at our own facility. We still focus on hand crafted instrumentation that meets surgeon's requirements.

Over the years, "Genetic" brand has maintained high standards of quality and continues to emphasize customer service and satisfaction. As surgical procedures need to change, "Genetic" will continue to meet new requirements for the specialty surgeons that it serves.

"*GENETIC INSTRUMENTS PVT LTD*" has been certified of FIRST SURVEILLANCE on the ISO 9001:2008 quality management system and CE Certified Manufacture and supply open surgery instruments.

WARRANTY

Instruments bearing the GENETIC name are of appropriate design and the finest quality. Each instrument is fully Guaranteed for the quality of material and workmanship and has been subjected to an established quality control.

GENETIC warrants all instruments stamped or etched with "GENETIC" Logo or name shall be free from manufacturing defects in material or workmanship for ONE YEAR.

TABLE OF CONTENT

B.P.Handle	1
Scissors	2-9
Needle Holders	10-12
Hemostatic	13-17
Dissecting Forceps	18-20
Retractors	21-35
Intestinal Clamps	36-37
Yaunker Tube & Trocar	38
Kidney Stone Forceps	39
Speculam	40
Cervical Punch & Screw	41
Uterine Dilators, Currettes, Forceps,	42-44
Podiatry instruments	45
Probes/Cannula	46-47
Rib Spreaders & Contractors	48-51
Lung Retractor & Spatula	52
Wire Cutter Twister	53
Vascular Forceps & Clamps	54-59
Mouth Gag & Nasal Instruments	60-63
Bone Instruments	64-77
Amputation Saw	78
Rochard Abdominal Retractor	79
Liver Transplant Retractor	81
Book Walter Type, Retractor System	87-90
Upper Abdominal Retractor System	91-92
Cannula	93



No.3
BPH-113



No.4
BPH-114



No.7
BPH-117



No.3L
BPH-007



No.4L
BPH-004



No.7L
BPH-007 L

Handle 3L, 7, 3L, 7L - to Fit Blade - 10, 11, 12, 15 - 3, 7
Handle 4, 4L - to Fit Blade - 20, 21, 22, 24



Blunt / Blunt

Dressing Scissors, Straight

SDR-505	size
SDR-506	5"
SDR-507	6"
SDR-508	7"
	8"



Sharp / Blunt

Dressing Scissors, Straight

SDR-105	size
SDR-106	5"
SDR-107	6"
SDR-108	7"
	8"



Sharp / Sharp

Dressing Scissors, Straight

SDR-305
SDR-306
SDR-307
SDR-308



Blunt / Blunt

Dressing Scissors, Curved

SDR-605	Size
SDR-606	5"
SDR-607	6"
SDR-608	7"
	8"



Sharp / Blunt

Dressing Scissors, Curved

SDR- 205	Size
SDR- 206	5"
SDR- 207	6"
SDR- 208	7"
	8"



Sharp / Sharp

Dressing Scissors, Curved

SDR-405
SDR-406
SDR-407
SDR-408

Straight

Curved



Baby Metzenbanum

Straight	size	Curved
SMZ-103	3"	SMZ-203
SMZ-104	4"	SMZ-204

Straight

Curved



Iris Scissors, 5"

SIR 555

SIR 666

Straight

Curved



Cutical Scissors 4 1/2"

SCC-400

SCC-500



Health suture removal scissors

6' SSC - 006

7' SSC - 007



Umbilical Scissors, 5 1/4"

SCU-514



Brawn Episiotomy Scissors,
Angled, 6 1/4"

SEP-200



Tube Cutter

6" TCS-100

7 1/4" TCS-101



Listers Bandage Cutting
Scissors

6" SBC-600

8" SBC-800



Shop Scissors 8"

SBC-100



Littauer Ligature Scissors 5"

SLC-500



Wire Cutting Scissors Angled, 5"
SWC-100



Wire Cutting Scissors Angled, 5" TC
SWC-200



Tylor Dural Scissors
7" FDS-170
6" TDS-145



Steven's Tenotomy Scissors, 4 1/2"



Straight
STY-305



Curved
STY-405



Jamison Scissors

Straight	size	Curved
SJN - 405	5"	SJN - 505
SJN - 406	6"	SJN - 506
SJN - 407	7"	SJN - 507
SJN - 408	8"	SJN - 508



Mayo Stille Scissors



Mayo Stille Scissors, Tungsten Carbide

Straight	size	Curved
SMA-305	5"	SMA-405
SMA-306	6"	SMA-406
SMA-307	7"	SMA-407
SMA-308	8"	SMA-408
SMA-309	9"	SMA-409
SMA-310	10"	SMA-410

Straight	size	Curved
SMA-805	5"	SMA-705
SMA-806	6"	SMA-706
SMA-807	7"	SMA-707
SMA-808	8"	SMA-708
SMA-809	9"	SMA-709
SMA-810	10"	SMZ-710

Metzenbaum Scissors



Metzenbaum Scissors

Metzenbaum Scissors, TC

Straight	size	Curved
SMZ-105	5"	SMZ-205
SMZ-106	6"	SMZ-206
SMZ-107	7"	SMZ-207
SMZ-108	8"	SMZ-208
SMZ-109	9"	SMZ-209
SMZ-110	10"	SMZ-210

Straight TC	size	Curved TC
SMZ-505	5"	SMZ-605
SMZ-506	6"	SMZ-606
SMZ-507	7"	SMZ-606
SMZ-508	8"	SMZ-608
SMZ-509	9"	SMZ-609
SMZ-510	10"	SMZ-610

Pott's Scissors

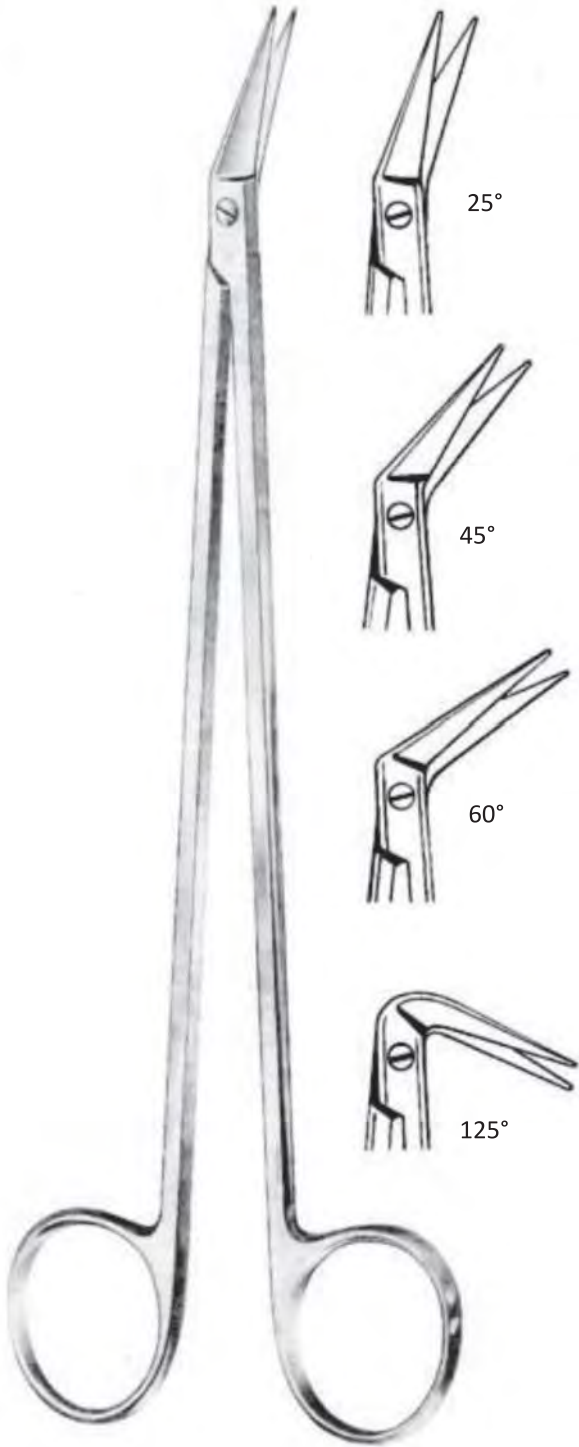

Pott's Vascular Scissors, 7 1/2"

- 25° PTS - 025
- 45° PTS - 045
- 60° PTS - 060
- 125° PTS - 225

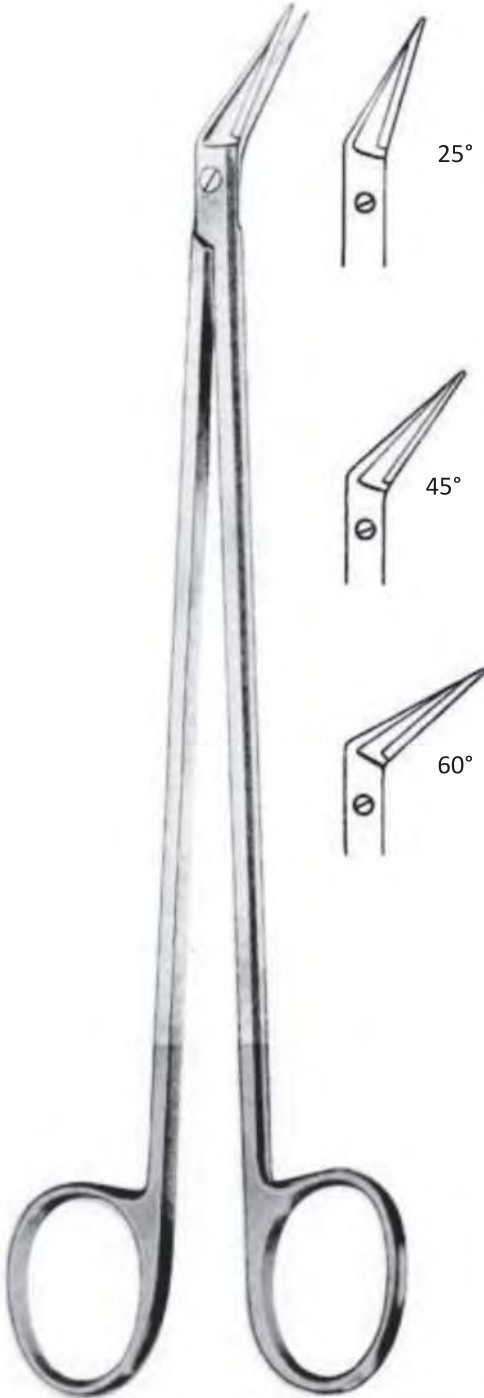

Pott's Vascular Scissors, 7 1/2 " T C

- 25° PTS -125
- 45° PTS - 145
- 60° PTS - 160



Dietrich Pott's Scissors, 7 1/2"

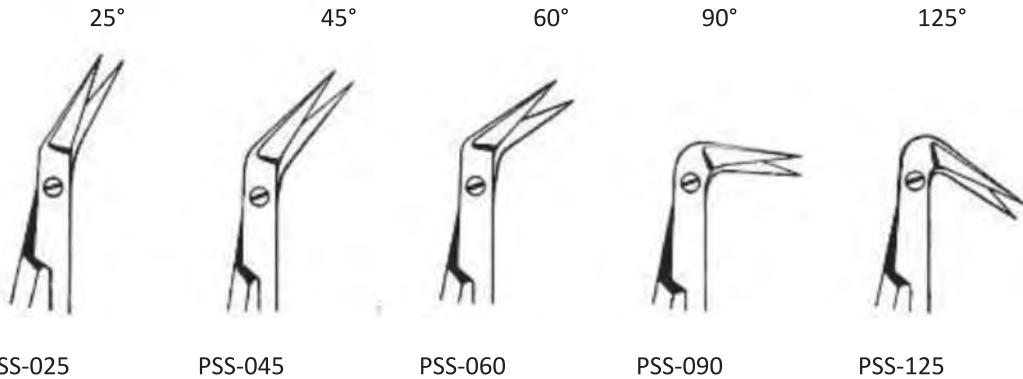

Micro Pott's Scissors, Flat Handle, 7"

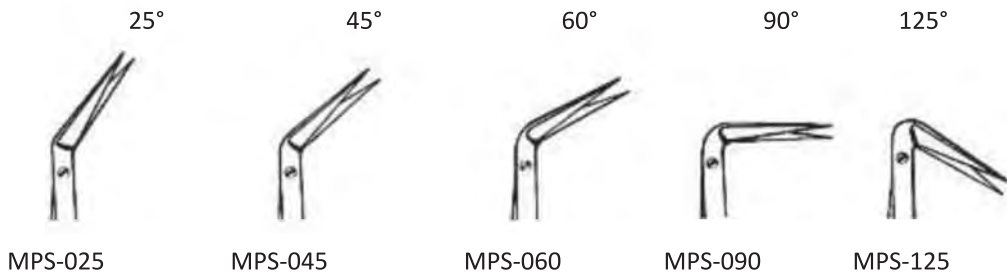



Halsey, 5"
NHH-105



Webster, 5"
NHW-105



Derf, 4 3/4"
NHD-105



Mayo Heggar
5" NHM-105
6" NHM-106
7" NHM-107
8" NHM-108
9" NHM-109
10" NHM-110
12" NHM-112



Crilewood
5" NHC-205
6" NHC-206
7" NHC-207
8" NHC-208
9" NHC-209
10" NHC-210
12" NHC-212



Gillies, 6 1/2"
NHG-200

Needle Holder TC Jaw



Halsey, 5"
NHH-013



Webster, 5"
NHW-013



Derf, 5"
NHR-012



Converse, 5"
NHC-015



De Bakey
5" NHD-505
6" NHD-506
7" NHD-507
8" NHD-508
9" NHD-509
10" NHD-510
12" NHD-512



Mayo Hegar
5" NHM-605
6" NHM-606
7" NHM-607
8" NHM-608
9" NHM-609
10" NHM-610
12" NHM-612



Crilewood
5" NHC-555
6" NHC-556
7" NHC-557
8" NHC-558
9" NHC-559
10" NHC-560
12" NHC-562

Needle Holder TC Jaw



Ryder

- 5" NHR-050
- 6" NHR-100
- 7" NHR-200
- 8" NHR-300
- 9" NHR-400



Bozemann, 8"

NHB-608



Jacobson, Flat Handle with Lock

- 7" CVN-700
- 8" CVN-800
- 9" CVN-900



Jacobson, Round Handle with Lock

- 7" JRN-700
- 8" JRN-800
- 9" JRN-900

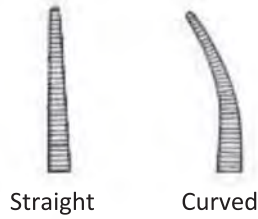

Mosquito Artery Forceps

Straight	size	Curved
MAS-035	3 ½"	MAC-035
MAS-004	4"	MAC-004
MAS-005	5"	MAC-005

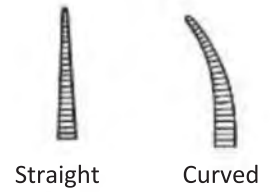

Micro Mosquito Artery Forceps

Straight	size	Curved
MMA-050	5"	MMA-051
MMA-060	6"	MMA-061
MMA-070	7"	MMA-071
MMA-080	8"	MMA-081

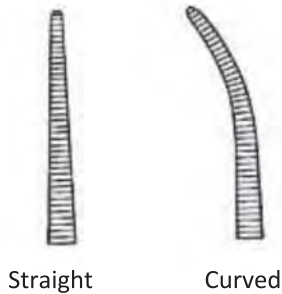

Crile Artery Forceps

Straight	size	Curved
AFS - 006	6"	AFC - 006
AFS - 007	7"	AFC - 007
AFS - 008	8"	AFC - 008
AFS - 009	9"	AFC - 009
AFS - 010	10"	AFC - 010
AFS - 011	11"	AFC - 012

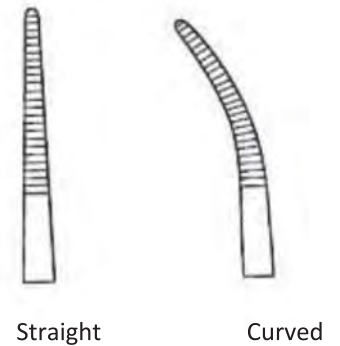

Kelly's Artery Forceps

Straight	size	Curved
AFK - 206	6"	AFK - 306
AFK - 207	7"	AFK - 307
AFK - 208	8"	AFK - 308
AFK - 209	9"	AFK - 309
AFK - 210	10"	AFK - 310

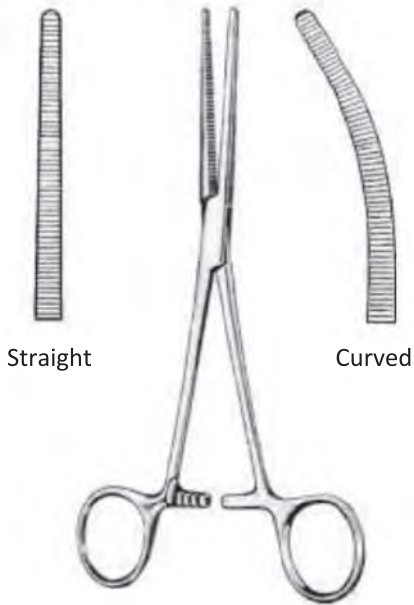

Roberts Artery Forceps

Straight	Size	Curved
RAF- 407	7"	RAF-507
RAF- 408	8"	RAF-508
RAF- 409	9"	RAF-509

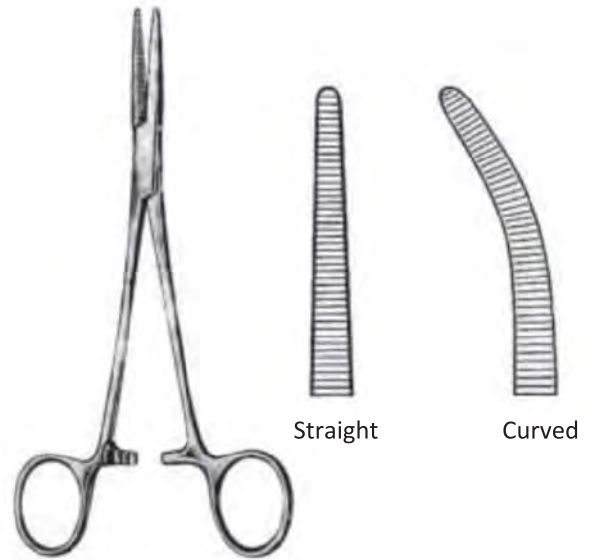

Spencer-Wells Artery Forceps

Straight	Size	Curved
AFS-005	5"	AFC-005
AFS-006	6"	AFC-006
AFS-007	7"	AFC-007
AFS-008	8"	AFC-008

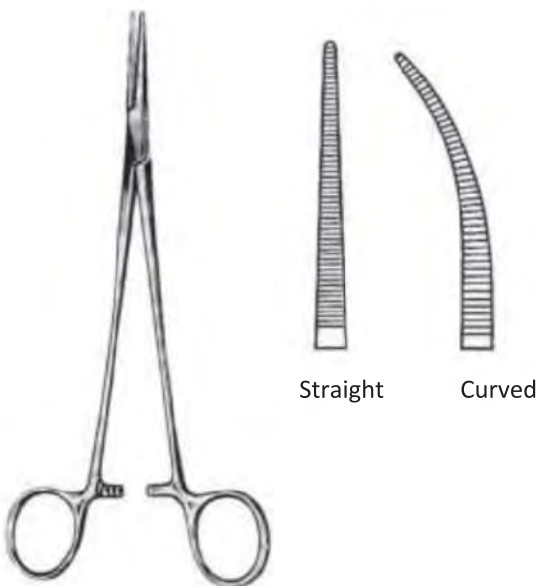

Tonsil Artery forceps

Straight	Size	Curved
AFT-207	7"	AFT-307
AFT-208	8"	AFT-308



Dandy Side Curved Artery Forceps

Size	
5"	DAF-005
6"	DAF-006

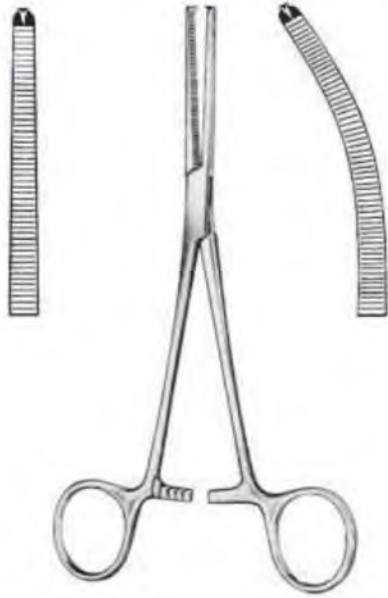

Kocher Artery Forceps

Straight	Size	Curved
KAF-505	5"	KAF-605
KAF-506	6"	KAF-606
KAF-507	7"	KAF-607
KAF-508	8"	KAF-608
KAF-509	9"	KAF-609
KAF-510	10"	KAF-610

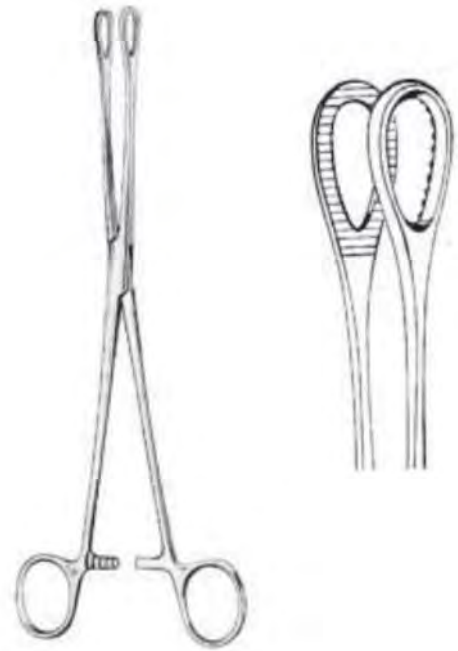

Sponge Holding Forceps

6"	SHF- 606
8"	SHF- 608
9"	SHF- 609
10"	SHF -610



Babcock Tissue Forceps

5"	TFB-115
6"	TFB-116
7"	TFB-117
8"	TFB-118
10"	TFB-110



Allis Tissue Forceps

5"	TFA-005
6"	TFA-006
7"	TFA-007
8"	TFA-008
9"	TFA-009
10"	TFA-010

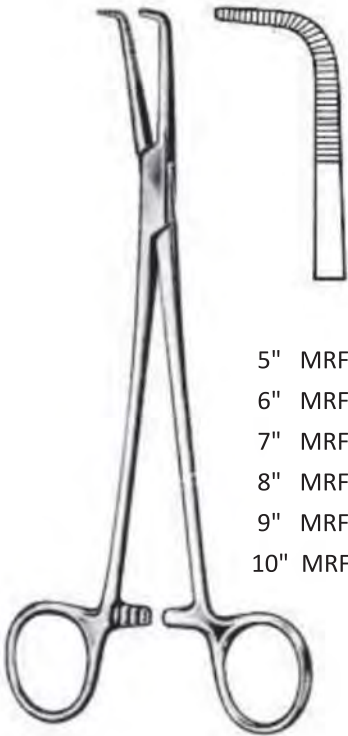

- 5" MRF-105
- 6" MRF-106
- 7" MRF-107
- 8" MRF-108
- 9" MRF-109
- 10" MRF-110

Mixture Right Angle Forceps

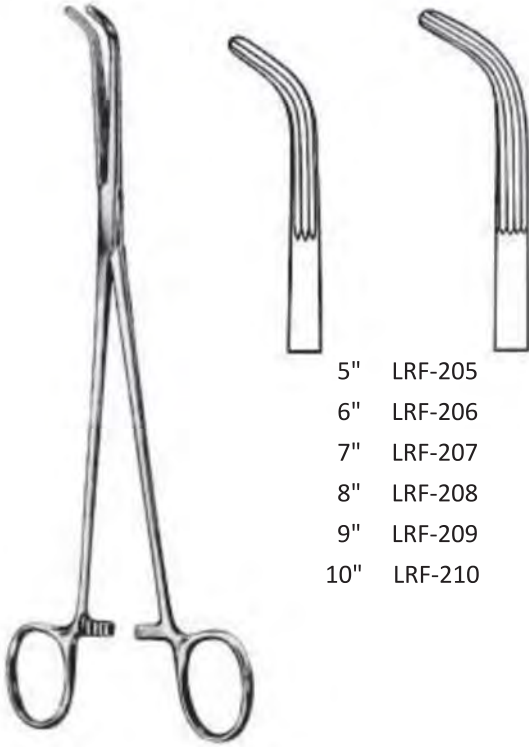

- 5" LRF-205
- 6" LRF-206
- 7" LRF-207
- 8" LRF-208
- 9" LRF-209
- 10" LRF-210

Lahey's Right Angled Forceps



Schadel

3 1/2" TCC-100



Backhaus Towel Clip

- 3 1/2" TCB-305
- 4" TCB-314
- 5" TCB-315
- 6" TCB-316
- 7" TCB-317



Lane Tissue Forceps

- 6" TFL-206
- 7" TFL-207
- 8" TFL-208



Heany's Forceps 8 ¼"



Single
CHN 108
CHN-208



Double
CHN-308, Straight
CHN-408, Curved

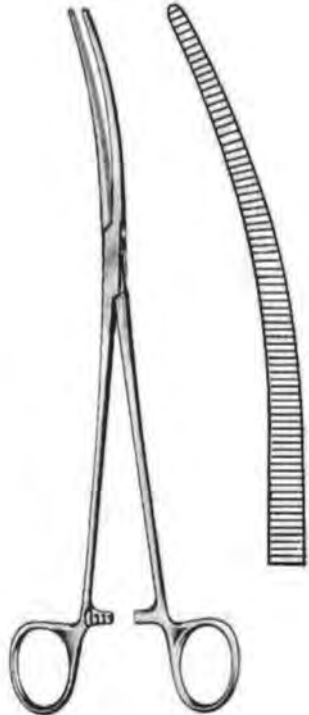

Craford Forceps, 9 ½"

AFC-200



Towel clip Ball & Socket

TCB - 915

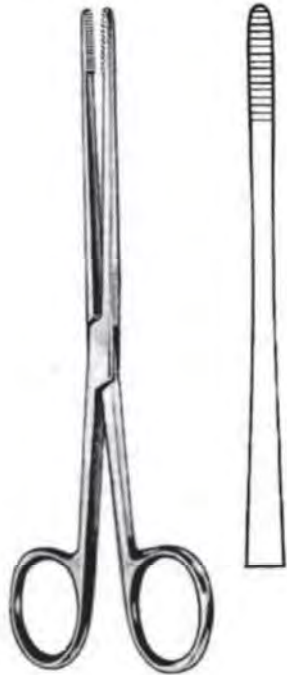

Lister's Sinus Forceps 6 ¼"

LSF-165

Dissecting Forceps



Standard



Fine



Standard



Fine

Dissecting Forceps, Non Toothed

DFP-005	5"	DFP-005F
DFP-006	6"	DFP-006F
DFP-007	7"	DFP-007F
DFP-008	8"	DFP-008F
DFP-009	9"	DFP-009F
DFP-010	10"	DFP-010F
DFP-012	12"	DFP-012F

Dissecting Forceps, Toothed

DFT-005	5"	DFT-005F
DftT-006	6"	DFT-006F
DFT-007	7"	DFT-007F
DFT-008	8"	DFT-008F
DFT-009	9"	DFT-009F
DFT-010	10"	DFT-010F
DFT-012	12"	DFT-012F



Gillies,

Non Toothed		Toothed	
GDF-005	5"	GDF-500	
GDF-006	6"	GDF-600	
GDF-007	7"	GDF-700	
GDF-008	8"	GDF-800	



Cushing

Non Toothed		Toothed	
CDF-306	6"	CDF-206	
CDF-307	7"	CDF-207	
CDF-308	8"	CDF-208	



McIndoe

Non Toothed		Toothed	
MDF-506	6"	MDF-606	
MDF-507	7"	MDF-607	
MDF-508	8"	MDF-608	

Dissecting Forceps



Nelson, 9"

NDF-009



Gerald

GDF 180 7" 1x2 TEETH



Gerald

7" GDF-070
8" GDF-080
9" GDF-090



Bayonet

Non Toothed	Toothed
BDF-055	5 1/2" BDF-155
BDF-065	6 1/2" BDF-165
BDF-075	7 1/2" BDF-175
BDF-085	8 1/2" BDF-185



Tuttle

7" TDF-007
8" TDF-008
9" TDF-009



Waugh

6" DFW-006
7" DFW-007
8" DFW-008



Mayo Russian

9 1/2" MRF-950
8" MRF-800



Bonneys

Non Toothed	Toothed
7" DFB-080	DFB-180



Adson



Adson Brown 7x7 teeth

Adson			Micro Adson		
Non Toothed	Size	Toothed	Non Toothed	Size	Toothed
ADF - 150	5"	ADF - 250	ADF - 100	5"	ADF - 200
ADF - 160	6"	ADF - 260	ADF - 101	6"	ADF - 201
ADF - 170	7"	ADF - 270	ADF - 102	7"	ADF - 202
ADF - 180	8"	ADF - 280	ADF - 103	8"	ADF - 203

5" ABF 250

0.15 mmx110mm



JMF-115

0.2mmx110mm



JMF-112

0.2mmx115mm



JMF-215

0.3mmx110mm



JMF-113

Jewellers Forceps



Gillies Skin Hook, 7"

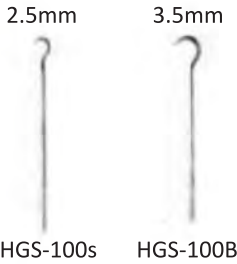

HGS-100s HGS-100B



Nerve Hook



HNE - 100 Sharp
HNE - 200 Blunt



Senn-Muller (Cats Paw) Retractor,
D/E, 6 3/4"



Sharp
RKR-500



Blunt
RKR-600



Mini Langenback Hand Retractor, 6 1/2"



- RLB-001 10x6mm
- RLB-002 17X5mm
- RLB-003 20X6mm
- RLB-004 22X8mm
- RLB-006 16X6mm
- RLB-007 25X6mm



Retractor 6"



Sharp
RSH-100



Blunt
RSH-101



Sharp
RDH-200



Blunt
RDH-201



Sharp
RDH-300



Blunt
RDH-301



Sharp
RDH-400



Blunt
RDH-401



Roux, (Set of 3)

- 5 1/2" RCL-005, Small
- 6" RCL-006, Medium
- 6 3/4" RCL-007, Large



U.S Army Pattern D/E, 8 1/4", (Set of 2)
RUS-220



Parker, (Set of 2)
RPL-100



Kelly's 10 1/2"

- RKY-100 38 mm
- RKY-200 55 mm
- RKY-300 75 mm



Doyen 9"

- RDO-401 30x40 mm
- RDO-402 40x60 mm
- RDO-403 65x85 mm



Morris 9"

- RMO-201 30x40 mm
- RMO-202 35x50 mm
- RMO-203 65x65 mm



Sharp



RRK-202



RRK-203



RRK-204



RRK-205

RRK-205



Blunt



RRK-302



RRK-303



RRK-304



RRK-305

RRK-306

Volkman (Rake) Retractor, 8 3/4"

Kocher Bone Hook, 8 3/4"



RBH-100
Small



RBH-101
Medium



RBH-102
Big



RBH-200
Small



RBH-201
Medium



RBH-202
Big

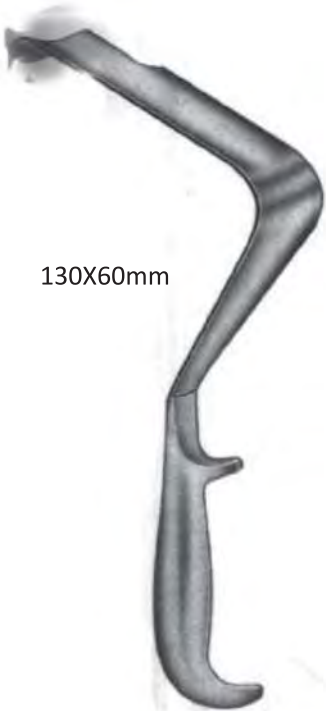

130X60mm

St. Marks, 11 1/2", with Lip
SPR-001 - 130x60mm

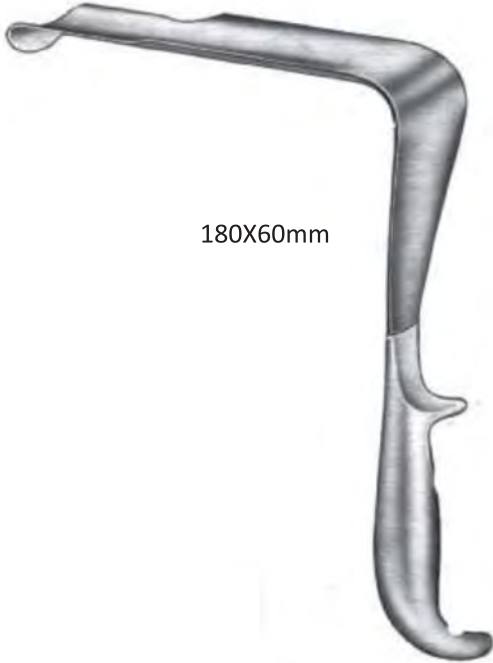

180X60mm

St.Marks, 13", with Lip
SPR-002 180x60mm

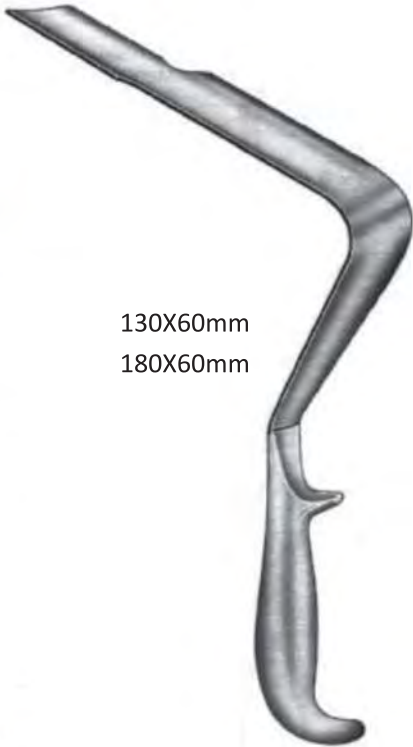

130X60mm
180X60mm

St. Marks, 13", without Lip
SPR-003 - 130x60mm
SPR-004 - 180x60mm



- RDE-200 - 4mm
- RDE-201 - 6mm
- RDE-202 - 8mm
- RDE-203 - 10mm
- RDE-204 - 12mm
- RDE-205 - 14mm
- RDE-206 - 16mm
- RDE-207 - 18mm
- RDE-208 - 20mm
- RDE-209 - 22mm
- RDE-210 - 24mm

Desmarres Eyelid Retractor, 5 1/2"



Retractor
RCZ - 100



Zenker, 9 1/2"



- RLB-101 - 25X6mm
- RLB-102 - 35X8mm
- RLB-103 - 35X11mm
- RLB-104 - 35X15mm
- RLB-105 - 40X11mm
- RLB-106 - 55X11mm
- RLB-107 - 70X14mm
- RLB-108 - 80X12mm
- RLB-109 - 80X16mm
- RLB-120 - 65X25mm
- RLB-121 - 90X20mm
- RLB-131 - 30X10mm

Langenback Retractor, 8 ½"

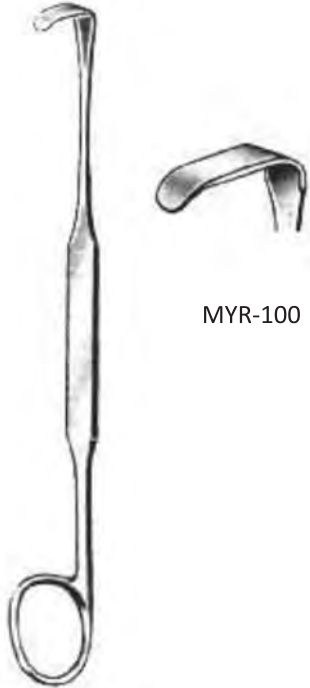

MYR-100

Meyerding Finger Retractor, 7"



- MRR-006 - 6mm
- MRR-008 - 8mm
- MRR-010 - 10mm
- MRR-012 - 12mm
- MRR-014 - 14mm
- MRR-016 - 16mm
- MRR-018 - 18mm
- MRR-020 - 20mm
- MRR-022 - 22mm
- MRR-812 - 12mm
- MRR-814 - 32mm
- MRR-825 - 25mm
- MRR-834 - 20mm
- MRR-835 - 38mm
- MRR-121 - 25mm
- MRR-122 - 38mm
- MRR-123 - 50mm
- MRR-124 - 65mm
- MRR-125 - 75mm

Malliable Retractor S.S. Type
Double Ended 8" & 12"



- MCR-006 - 6mm
- MCR-008 - 8mm
- MCR-010 - 10mm
- MCR-012 - 12mm
- MCR-014 - 14mm
- MCR-016 - 16mm
- MCR-018 - 18mm
- MCR-020 - 20mm
- MCR-022 - 22mm
- MCR-812 - 12mm
- MCR-814 - 32mm
- MCR-825 - 25mm
- MCR-834 - 20mm
- MCR-835 - 38mm
- MCR-121 - 25mm
- MCR-122 - 38mm
- MCR-123 - 50mm
- MCR-124 - 65mm
- MCR-125 - 75mm

Malliable Retractor, Copper Type,
Double Ended 8" & 12"

Hand Retractor



Deavers Child

- RDV-127 - 12mmx7"
- RDV-128 - 12mmx8"
- RDV-306 - 20mmx7"
- RDV-307 - 22mmx8 1/2"



Deaver Paediatric

- RDV-200 - 6.3mmx6 3/4"
- RDV-201 - 9.5mmx6 3/4"
- RDV-202 - 12.7mmx6 3/4"
- RDV-203 - 15.8mmx6 3/4"
- RDV-204 - 19mmx6 3/4"



Harrington Retractor

- RHR-135 - 127x40mm
- RHR-145 - 127x62mm



Deavers Retractor, 12"

- RDV-301 - 1"x12"
- RDV-302 - 1 1/2"x12"
- RDV-303 - 2"x12"
- RDV-304 - 2 1/2"x12"
- RDV-304 - 3"x12"



Deavers Retractor Grip Handle, 12"

- RDV-311 - 25mm Small
- RDV-312 - 38mm Medium
- RDV-313 - 50mm Large

Self Retaining Retractor



Alm Self Retaining Retractor, 4"
SRM-100



Jansen, 4 1/2"
SRM-101-Blunt



Jansen, 4 1/2"
SRM-102-Sharp



Plester, 5 1/2" Left
SRR-600



Plester, 4 3/4" Right
SRR-601



Gelpi,
4" SRR-504
5" SRR-505
6" SRR-506
7 1/2" SRR-508

Self Retaining Retractor



- 5" SRR-205
- 6" SRR-206
- 7" SRR-207
- 8" SRR-208
- 9" SRR-209
- 10" SRR-210

Weitlaner S/R Retractor, Straight



- 5" SRR-305
- 6" SRR-306
- 7" SRR-307
- 8" SRR-308
- 9" SRR-309
- 10" SRR-310

Mastoid (Mollison), S/R Retractor, Curved



- 5" SRR-405
- 6" SRR-406
- 7" SRR-407
- 8" SRR-408
- 9" SRR-409
- 10" SRR-410

Cone's Hinged Arms,



- Anderson Adson,
- 8" - SRR-315
- 10 3/4" - SRR-320

Self Retaining Retractor



Beckmann Adson, 12 1/2"
SRR-400



Beckmann Eaton, 12 1/2"
SRR-425



Beckmann Adson, 12 1/2"
SRR-440



Travers, 8 1/4"
SRT-825



Meyerding 6 1/2"
SRR-725

Self Retaining Retractor



Miskimon, 7 1/2" 7x7 Prongs
SRM-200



Backmann Eaton, 12 3/4" 7x7 Prongs
SRR-420



Henley, 6 1/2"
SRR-222



16X19mm 16X25mm 16X32mm

Self Retaining Retractor

100mm

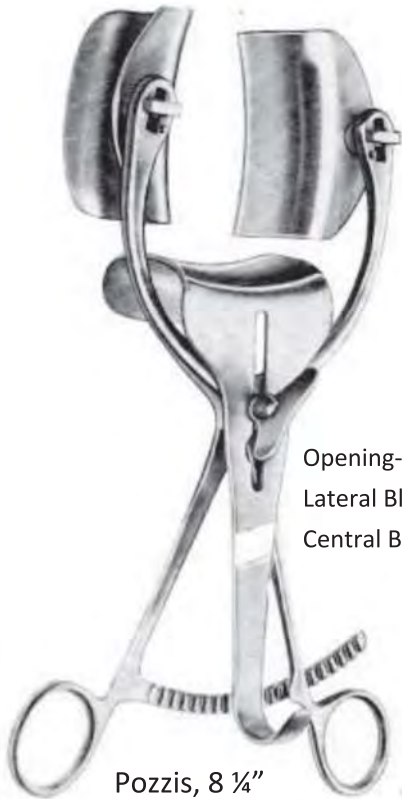

Opening-100mm
Lateral Blades-38x62mm
Central Blades-55x55mm

Pozzis, 8 1/4"
SRA-110



Opening-100mm
Laterl Blades-38x60mm

Collin, 7 1/2"
SRA-105

110mm



Opening - 110mm
Arm Length - 125mm
Scale Length - 115mm

Gosset,Child
SRA-120

140 mm



Opening - 140 mm
Central Blade- 65x60 mm
Lateral Blade - 65x28 mm

Gosset, Adult
SRA-125

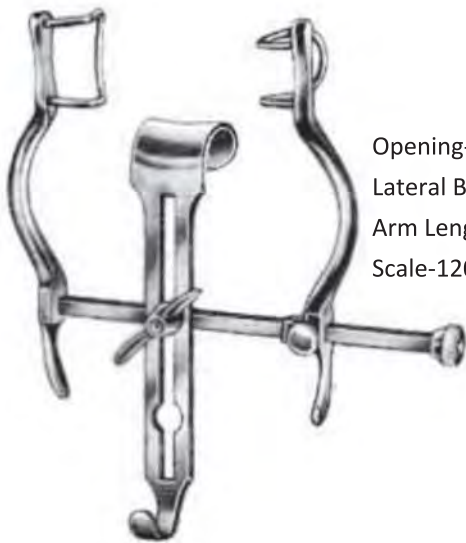

Opening-95mm
Lateral Blades - 24x20mm
Arm Length-95mm
Scale-120mm

Baby Balfour

SRA-130

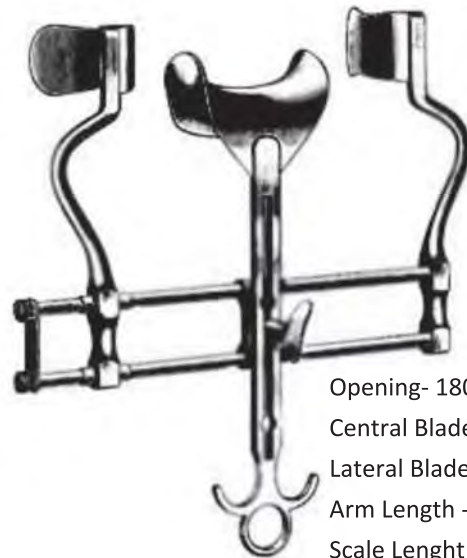

Opening- 180 mm
Central Blade- 45x80 mm
Lateral Blade- 70x35 mm
Arm Length - 200mm
Scale Length - 250

Balfour, Modified, Adult

SRR-204

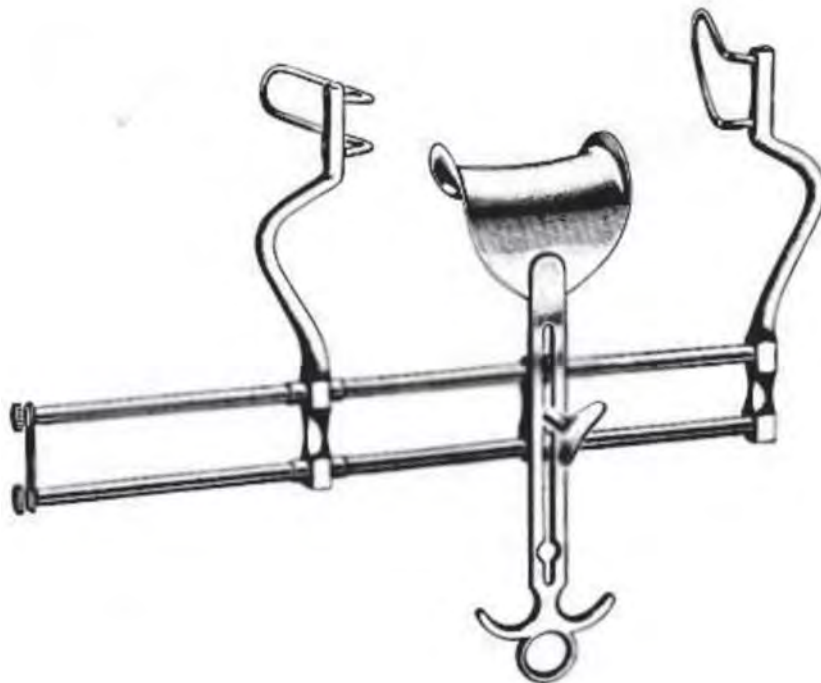

Balfour S/R Retractor

SRA-200
Opening- 170 mm
Central Blade- 45x65 mm
Lateral Blade- 60 mm
Arm Length - 200mm
Scale Length - 170mm

SRA-201
Opening- 250 mm
Central Blade- 65x85 mm
Lateral Blade- 80mm
Arm Length - 200mm
Scale Length -252mm

SRA-202
Opening- 270 mm
Central Blade-80x80 mm
Lateral Blade- 90 mm
Arm Length - 200mm
Scale Length - 270

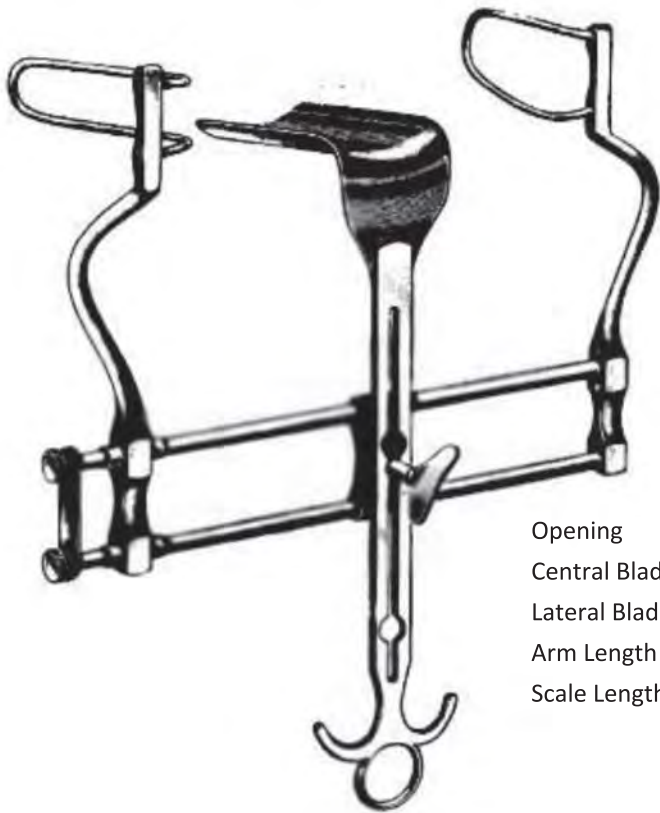

- Opening -200 mm
- Central Blade - 100x70 mm
- Lateral Blade -100x35 mm
- Arm Length - 200mm
- Scale Length - 450mm

Balfour S/R Retractor

SRA-555

Frame-250x180mm,Adult
Frame-180x140mm,Child



Dennis Browne
SRA-300-Adult
SRA-600-Child



Adult

38X38mm
38X25mm



Child

35X25mm
30X20mm

Bladder Retractor

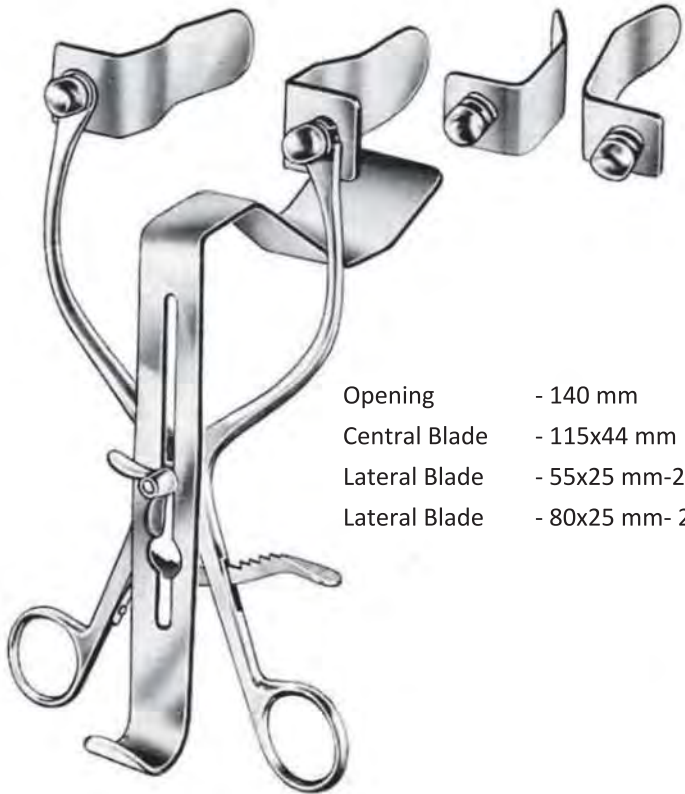

- Opening - 140 mm
- Central Blade - 115x44 mm
- Lateral Blade - 55x25 mm-2 Nos
- Lateral Blade - 80x25 mm- 2 Nos

Million Bladder Retractor

SRB-100



Bakes Bile Duct Dialator
(Set of 13)

DRB-550



Blake, 8"

GSF-020



Clutton's Urethral Dialator
(set of 12)
DRC-200



Vanburen
(set of 13)
DRV-250



Catheter Introducer, 13"
CIR-200



CIR-100



Kelly Proctoscope

Small, MIS-015
Medium, MIS-016
Large, MIS-017



Parks

PAR-100 - Small
PAR-200 - Large



Parks Anal Retractor with central blade
PAR-500



Hering Ring
HRF - 125



Doyen



6" Straight



6" Cur ved



7" Straight



7" Cur ved



8" Straight

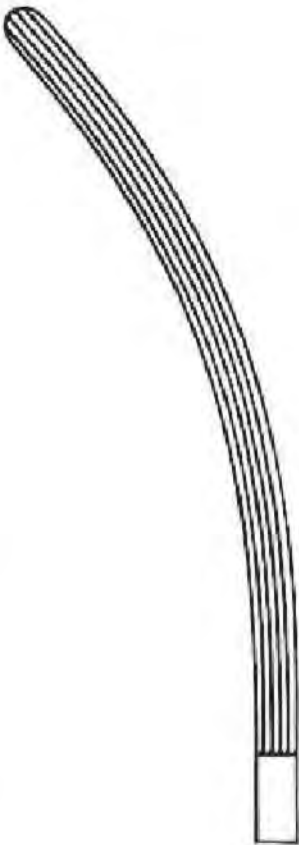

8" Cur ved



9 1/2" Str a i ght



9 1/2" Cur ved

Straight

- 6" ILC-460
- 7" ILC-470
- 8" ILC-480
- 9 1/2 " ILC-495

Curved

- 6" ILC-560
- 7" ILC-570
- 8" ILC-580
- 9 1/2" ILC-595

Intestinal Clamps



Kocher



6"

ILC-060



8"

ILC-080



9 1/2"

ILC-090



6"

ILC-260



8"

ILC-280



9 1/2"

ILV-290



Payrs

ILP-100 Child
 ILP-200 Medium
 ILP-300 Adult



6"



8 1/4"



11 1/2"

Yaunker Tube & Trocar



Yaunker, Adult , 10 ½ ”
SUY-001



Yaunker, Child,
SUY-002



Poole, 8 ¾” Straight
SUP-150, Adult 10mm
SUP-160 Child 8mm



Poole, 8 ¾” Curved
SUP-250, Adult 10mm
SUP-260, Child 8mm



Standard Nelson, 4
STC-555
STC-666



Universal, Set of 4
UTS-101



Nelson, 8 ¼”
Trocar & Canula
TSU-060-6mm
TSU-080-8mm
TSU-100-10mm



Fraizer
Size
1 SUM-001
2 SUM-002
3 SUM-003
4 SUM-004
5 SUM-005

Kidney Stone Forceps



Lane
Stomach Clamp, 12"



ITC-100

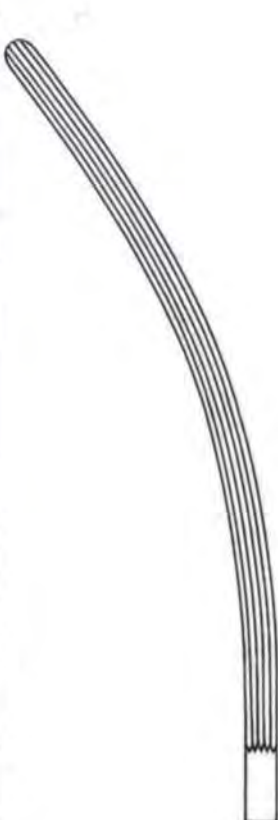

ITC-200



Desjardins, 9"

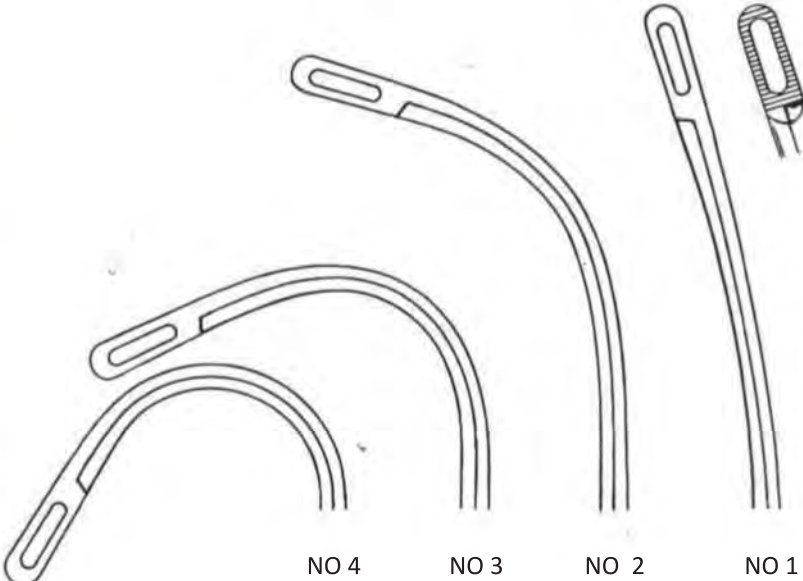

- No 1 GSF-001
- No 2 GSF-002
- No 3 GSF-003
- No 4 GSF-004



Sims Double end

- SVS-100-Smal
- SVS-200-Medium
- SVS-300-Large



Sims Single end

- SVS-010-Smal
- SVS-020-Medium
- SVS-030-Large



Cuscos

- VVS-10 - Large Narrow Type
- VVS-20 - Medium Narrow Type
- VVS-30 - Small Narrow Type



VSS-600

Auward Speculam



- RDO-400 55 mm
- RDO-500 85 mm
- RDO-600 115 mm

Doyen



Schumaker, 10 1/4"

CPB-300



Novak, 9"

UCN-125



Doyen Myoma Screw 6 3/4"

DMS-180



Doyen Myoma Screw 6 3/4"

DMS-150



Hegar (Set of 22)
Single Ended 1 to 22mm
DRH-200



Hegar (Set of 9)
Double Ended 1 to 18mm
DRH-400

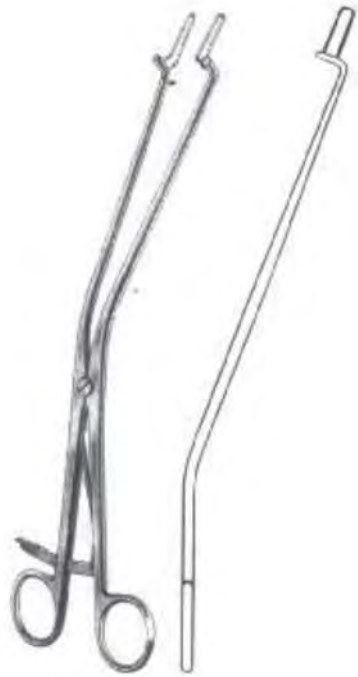

Kogen, 9 1/2"

Outlet Forceps



Wrigley, 11"
OLF-100



Milne Murray
OLF-200



Simpson-Braun, 14"
OLF-300

Uterine Elevating Forceps

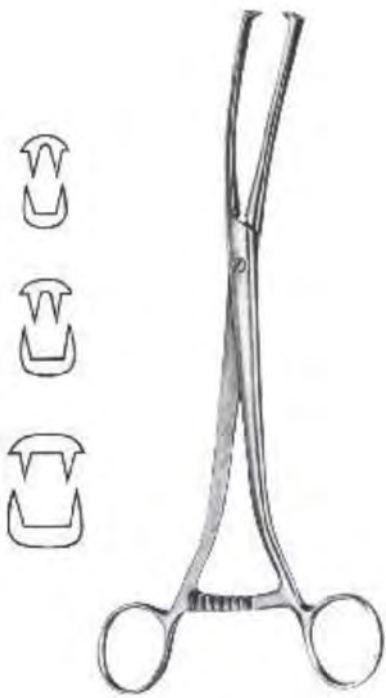

Museux, 9 1/2"
MVF-100



Noto, 10 1/2"
PPF-100



Somer, 9"
UEF-900



Teale
7" TVF-207
8" TVF-208
9" TVF-209
10" TVF-210



Tenaculam
9" UTF-090
10" UTF-100



Green-Armytage, 8 1/4"
GAF-500

Uterine Sounds & Currets



Sims Malleable 12 1/2"
DRS-100



Depressor 10"
SUD-260



Jolls (Twin Clamp)
RJT-300



Sims, 10"
SUC-222



7.5mm



8.5mm



10mm



11.5mm



13.5mm



14.5mm



Blake, 10 1/2"
SUC-300



POD - 100 POD - 101 POD - 102 POD - 103 POD - 104



POD - 111



POD - 112



POD - 106



POD - 105



POD - 108



POD - 107



POD - 110



POD - 109



Malleable Probe
6" PRM-006
8" PRM-008



Brodie
DTT-101
DTT-102



Jobson Horn Probe
JHP-180

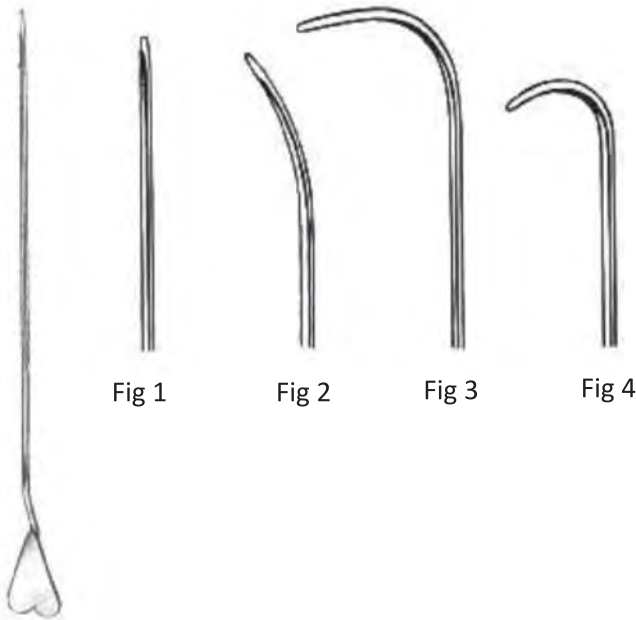

Lockhart Mummery Fistula Probe

- Fig 1 - FPL-001 Straight 5"
- Fig 2 - FPL-002 Curved 45°, 5"
- Fig 3 - FPL-003 Curved 90°, 5"
- Fig 4 - FPL-004 Retrograde, Curved 5"



Lachrymal Probe (set of 4)
GLP-004

Cannula & Vein Stripper

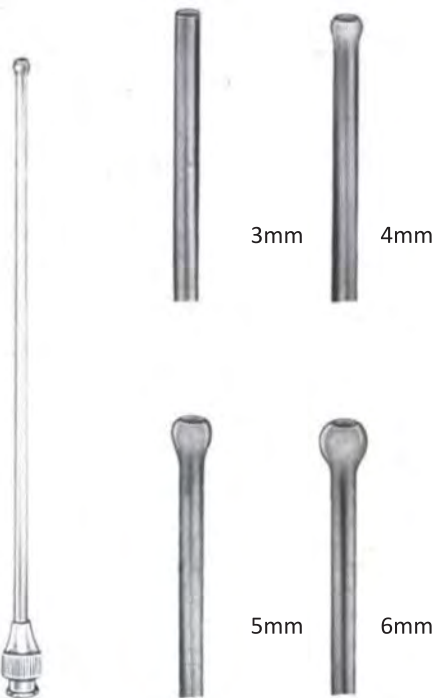

Schmid Irrigation Cannula

- 3mm VCA-103
- 4mm VCA-104
- 5mm VCA-105
- 6mm VCA-106



Heparin Vein Cannula

- VCA-100
- VCA-101

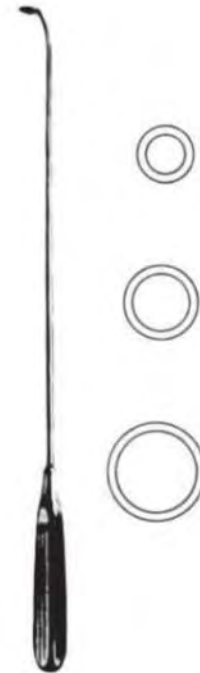

Mayo 10"

- VSR-100



Nabatoff

- NVS-100
- 135x100x25





Finochitto

RSF-050- 6x7mm

RSF-100
 Blade Size-18x21mm
 Opening - 75mm
 Arm Length - 75
 Scale - 95

RSF-300
 Blade Size -36x45mm
 Opening - 140
 Arm Length - 170
 Scale - 200

RSF-200
 Blade Size-28x32mm
 opening- 120
 Arm Length - 140
 Scale 180

RSF-400
 Blade Size - 45x65mm
 Opening - 210mm
 Arm Length - 200
 Scale - 260

RSF-500
 Blade Size - 65x65mm
 Opening - 210
 Arm Length - 220
 Scale - 260



Morse

SSM-155, Infant
 SSM-160, Child
 SSM-170, Medium
 SSM-175, Large
 SSM-180, Extra Large

Rib Spreader

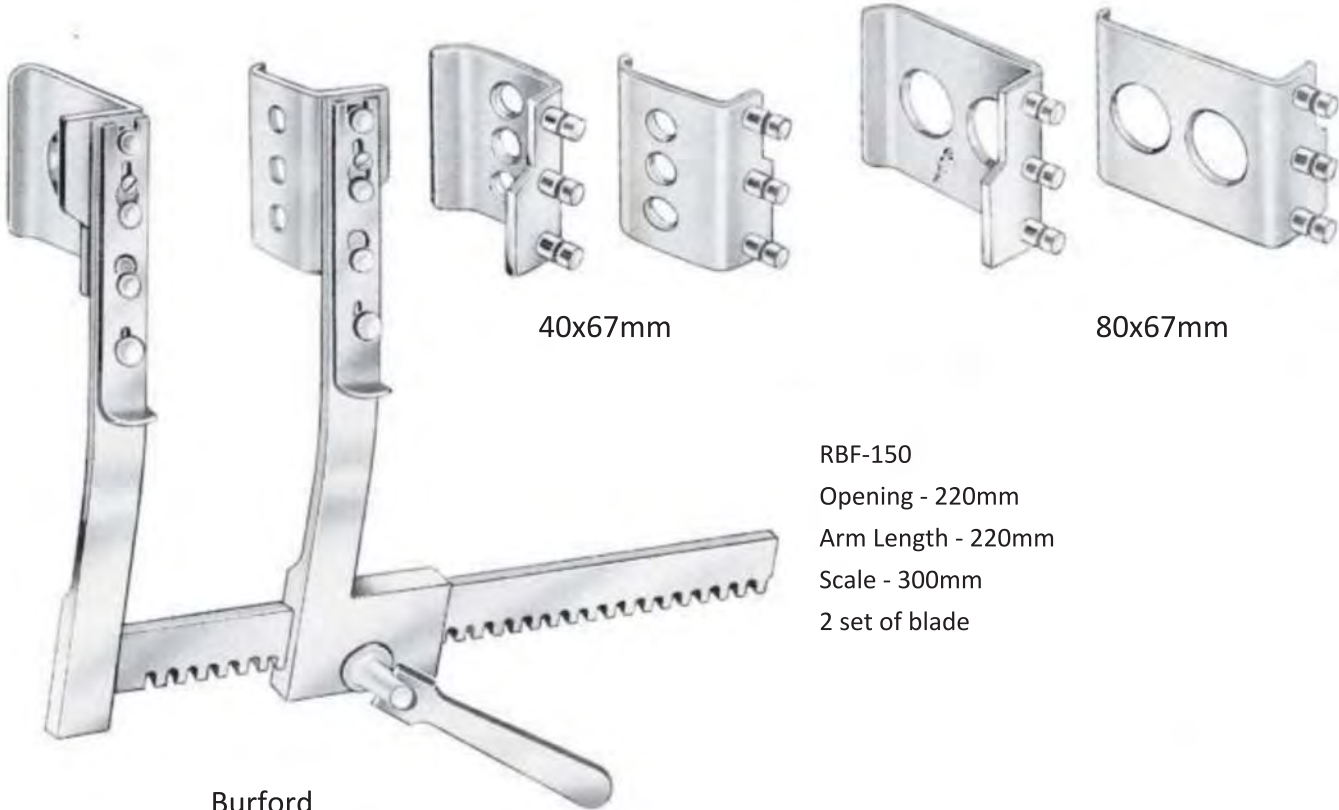

Burford

RBF-150
 Opening - 220mm
 Arm Length - 220mm
 Scale - 300mm
 2 set of blade



De Bakey

RSD-110-Extra Large
 With 10 Blades
 Opening - 200mm
 Arm Length - 225mm
 Scale - 285mm

RSD-106- Large
 With 6 Blades
 Opening - 150mm
 Arm Length - 180mm
 Scale - 220mm



Tuffier

RST-400, Adult

Opening- 130 mm
 Blade- 50x45 mm
 Arm Length - 125mm
 Scale - 170mm

Rib Contractor



Bailey, 8"
BRS-220



Baby Bailey, 5 1/2"
BRS-215



Sellors, 7 1/2"
BRS-300



With Guard

Tubing Clamp

- | | |
|-------------|---------------|
| With Guard | Without Guard |
| 6" TBC-206 | 6" TBC-306 |
| 8" TBC-208 | 7" TBC-308 |
| 10" TBC-210 | 8" TBC-310 |

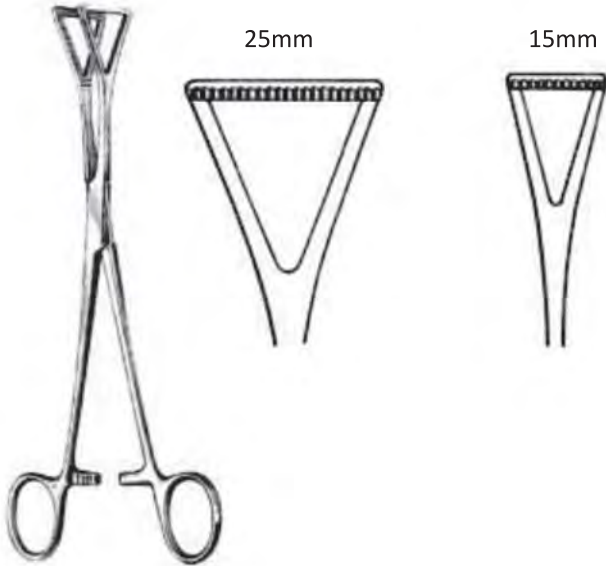

Duval Lung Holding Forceps

- 7" DLF-170-10mm
- 8" DLF-180-15mm
- 9" DLF-225-25mm
- 9" DLF-290-20mm



Semb, 8 1/2"

- ESR-910mm
- ESR-912mm
- ESR-913mm
- ESR-914mm
- ESR-915mm



Doyen, 6 3/4"

EDR-100-Left

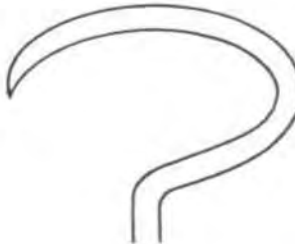
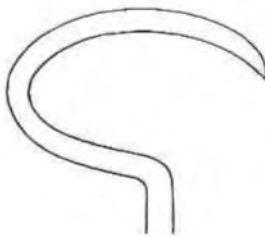

Doyen, 6 3/4"

EDR-200-Right

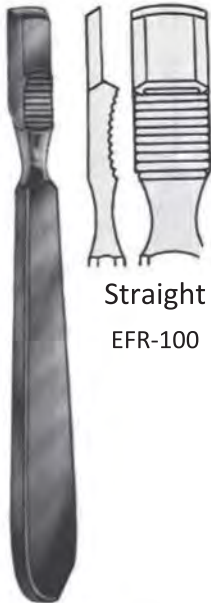

Farabeuf, 6"

Straight
EFR-100

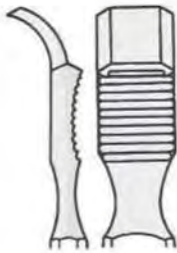

Curved
EFR-200

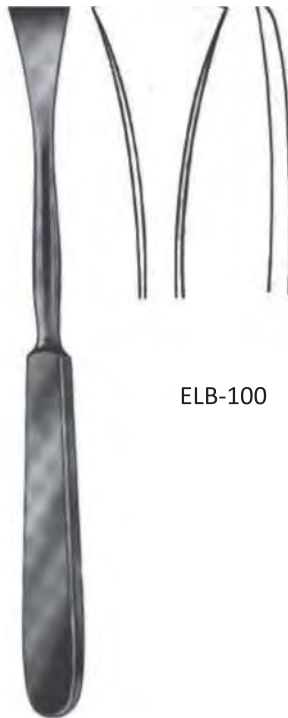

Langenback, 7"

ELB-100

Lung Retractor & Spatula



Right



Left



Allison Lung Spatula

- LRA-100-Adult
- LRA-110-Child

Cooley Mitral Valve Retractor

- CMR - 100-Small, Right
- CMR - 200-Medium, Right
- CMR - 300-Large, Right
- CMR - 400-left



- RAR-100Small
- RAR-200Medium
- RAR-300Large

Ross Aortic Retractor



- RDS-500-Small
- RDS-600-Large

Davison Scapula Retractor

Wire Cutter & Twister



Wire Cutter, Double Action, T.C
WCS-103, 8 1/4"



Wire Cutter, T.C
WCA-700, 6 1/2"





BerrySternal Needle Hoderl, TC, 8"
NHB-100, TC Jaw,



Wire Twister, T.C
8" WTB-750
6" WTB-500

Vascular Forceps & Bulldog Clamps



			
	1.5mm	2mm	2.8mm
6"	DVF- 615	DVF-620	DVF- 628
7"	DVF -715	DVF-720	DVF-728
8"	DVF- 815	DVF- 820	DVF- 828
9"	DVF- 915	DVF- 920	DVF- 928

Debakey Dissecting Forceps



	2mm
	Angled
6"	DVF-160
8"	DVF-180
9 1/2"	DVF-195

Debakey Dissecting Forceps, Angled



Bulldog clamp, Straight

DBG-115	1 1/2"
DBG-120	2"
DBG-125	2 1/2"
DBG-130	3"
DBG-135	3 1/2"
DBG-140	4"









Bulldog Clamp, Curved

DBG-215	1 1/2"
DBG-220	2"
DBG-225	2 1/2"
DBG-230	3"
DBG-235	3 1/2"
DBG-240	4"



Diethrich Bull Dog Clamp

	8mm		12mm		16mm
	8mm		12mm		16mm

Staright		Angled
BGD-080	8mm	BGD-108
BGD-011	12mm	BGD-111
BGD-020	16mm	BGD-222

Ring Handle Bulldog Clamp



DRB-050, 5" Curved, 45mm jaw



DRB-150



DRB-100



DRB-115



Debakey Ring Handle
DRB-200 - 40mm jaw, 90°, 4 1/2"

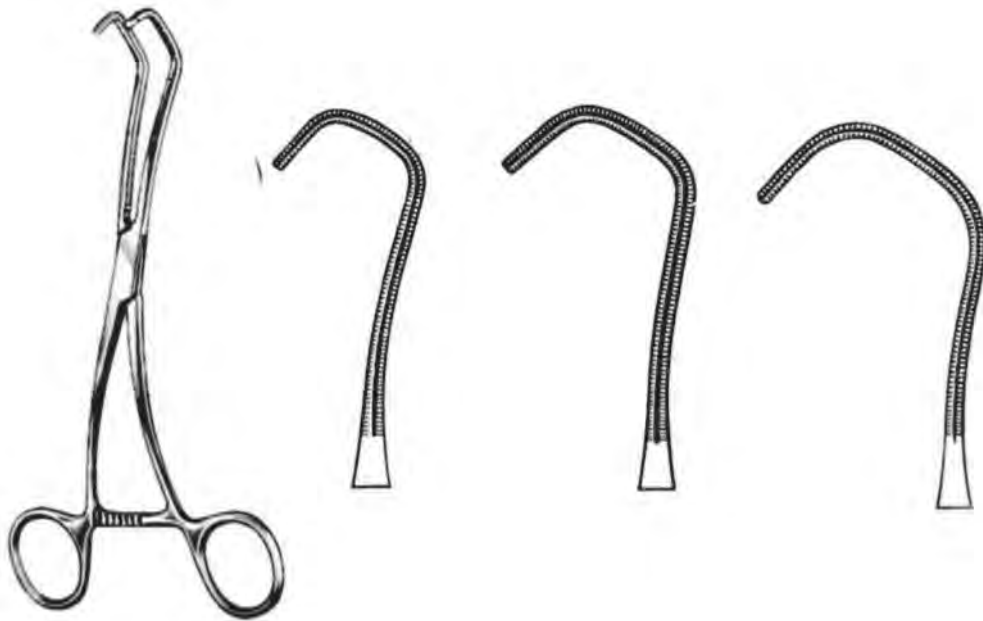

Debakey Derra

Vascular Clamps

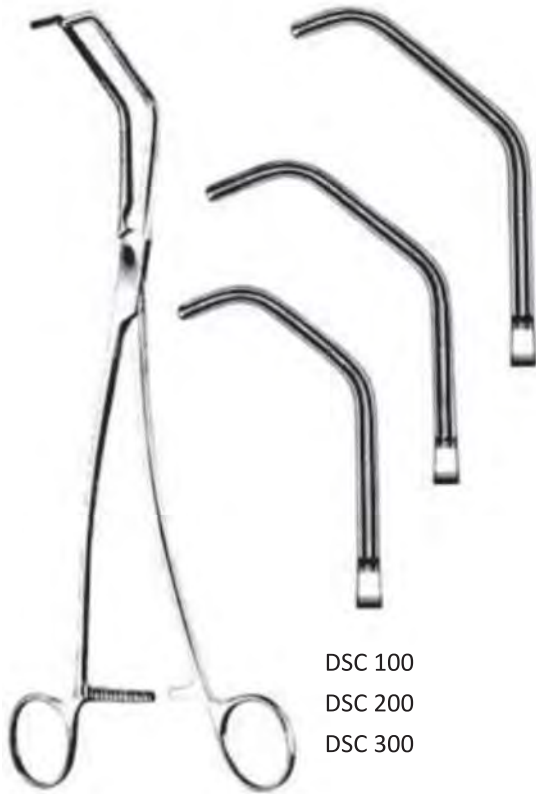

Satinsky

DSC 100
DSC 200
DSC 300

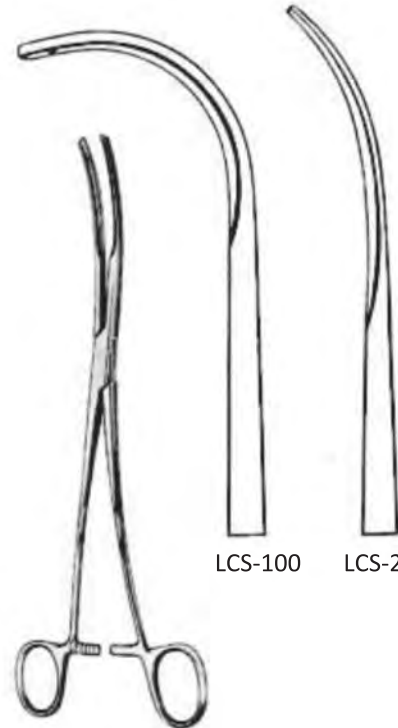

Semb, 9 1/2"

LCS-100 LCS-200



Aneurysm Clamp



10"

10 1/2"

11"

DAC-100

DAC-200

DAC-300

Vascular Clamps



Tangential Occlusion Clamp

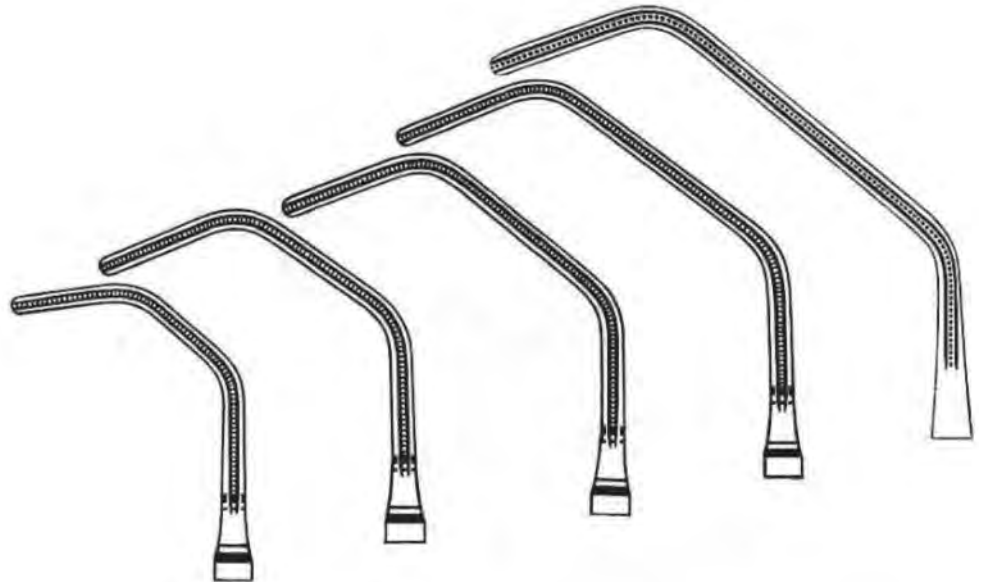

- | | | | | |
|---------|---------|---------|---------|---------|
| 8" | 10" | 10 ¾" | 10 ½" | 11" |
| DTO-001 | DTO-002 | DTO-003 | DTO-004 | DTO-005 |
| No:1 | No:2 | No:3 | No:4 | No:5 |



Lees Brochuc Clamps

90° 9 ¾" DBC 100



Lees Brochus Clamps

9 ¾" DBC 200



Glover Anastomosis Clamp

Curved 48mm 8 ½" DGA 042
 "S" Shapped 52mm 8 ¾" DGA 052

Vascular Clamps



10"

DAA-020

12"

DAA-030

12 ½"

DAA-040

13 ⅞"

DAA-010

Price Thomas, 8 ¾"

PAC-100, Regular Jaw

Aortic Aneurysm Clamp



Harken, 9 ½"

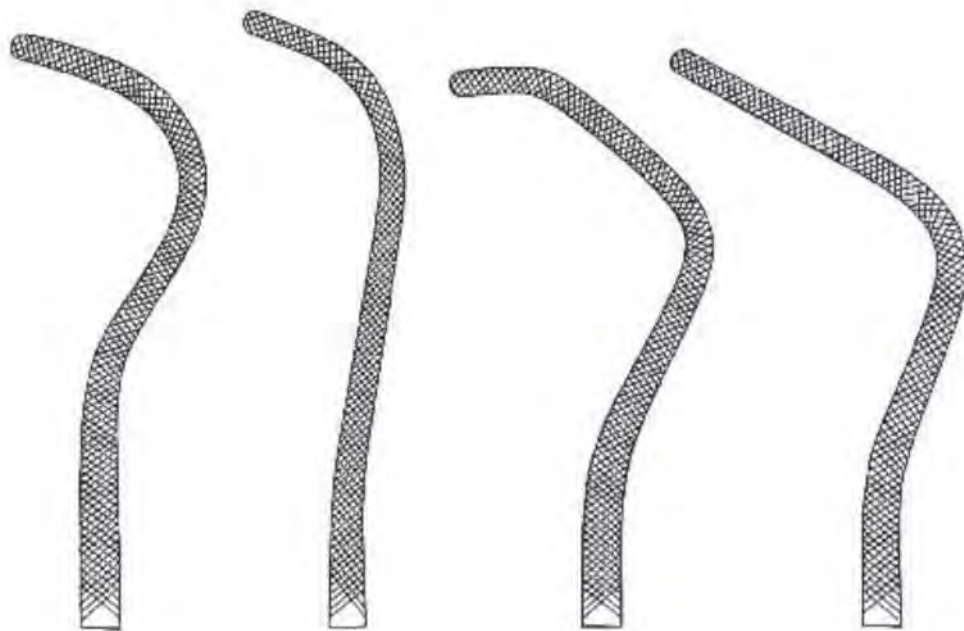

DHC-100

DHC-200

DHC-300

DHC-400



Doyen

4" MGD-100, Small
4 3/4" MGD-125, Medium,
5 1/2" MGD-150 Big



Davis Boyles
(Set of 5 Blades)



MGD-444, Adult
MGD-333, Child



Dingmann Mouth Gag with Suture Carrier

MGD-555



Fig.1

Fig.3

Adenoid Currete & Knife

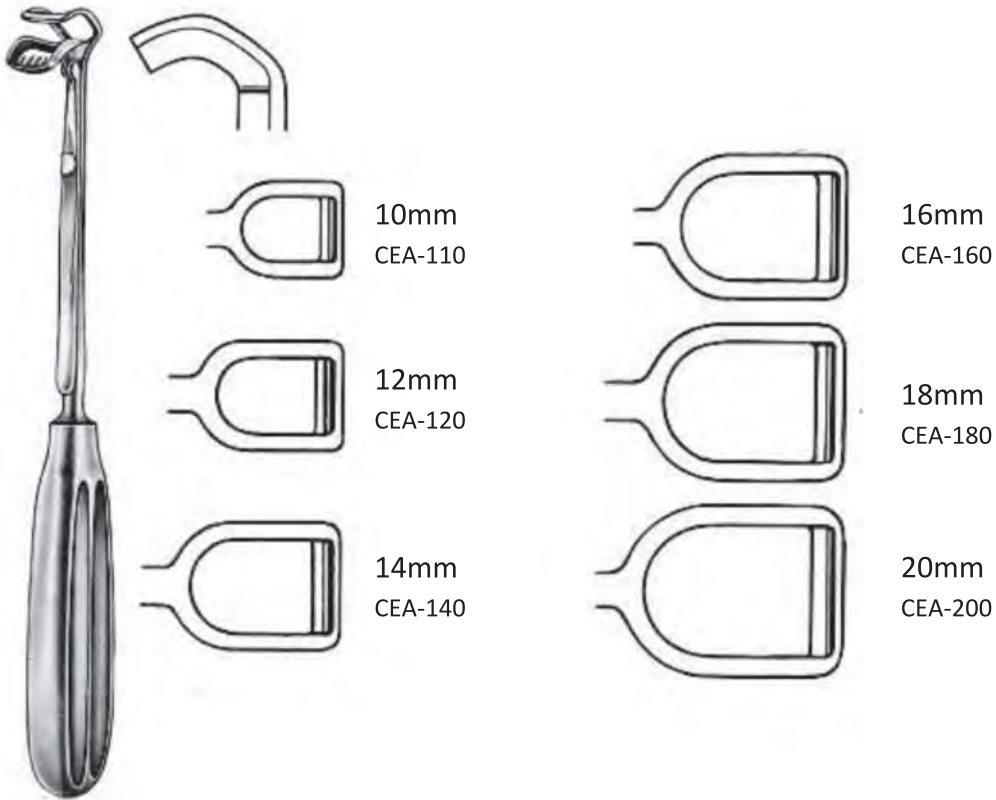

Adenoid, 8 1/2"



Balanger, Straight
BSK-130



Balanger, Bayonet
BSK-230



Tracheal Dialator
TRT-040 Small
TRT-050 Medium
TRT-060 Big

Nasal Dressing Forceps



Tilles

TNF-150



Magils

6" MSF-060-Child
8" MSF-080-Medium
10" MSF-110-Adult



Luc's

LNF-001-Small
LNF-002-Medium
LNF-003-Big



Aural
ADF-125

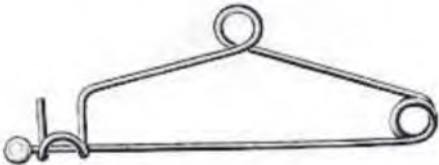

Mayo's Safety Pin
6" MSP-060
8" MSP-080
10" MSP-010



Asch Forceps, 23cm
ASF-100



Walshem Spectem Forceps
WSF - 100 Right
WSF - 101 Left

Nasal Speculam

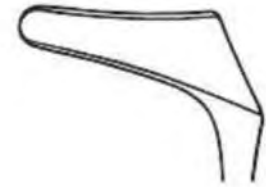

NSK-001

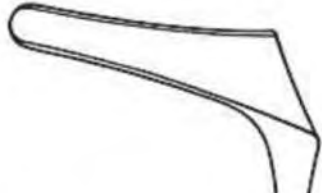

NSK-002

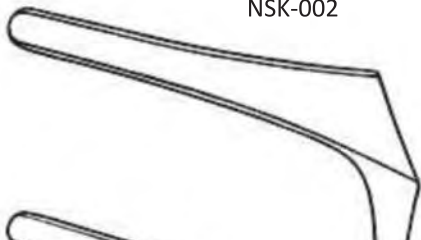

NSK-003

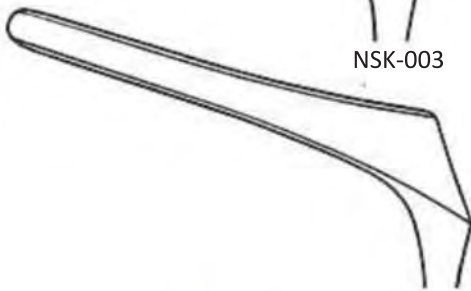

NSK-004



Killian



Fergusson

FMG-100



Tongue Depressor

- TOD-145 Small
- TOD-155 Medium
- TOD-165 Large

Bone Currets & Raspatories



- 0 BSV-001
- 00 BSV-002
- 000 BSV-003
- 0000 BSV-004
- 1 BSV-010
- 2 BSV-020
- 3 BSV-030
- 4 BSV-040
- 5 BSV-050
- 6 BSV-060

Volkmann, 6 3/4"



Straight	Down
000 BSS-100	200
00 BSS-101	201
0 BSS-102	202
1 BSS-103	203
2 BSS-104	204
3 BSS-105	205
4 BSS-106	206
5 BSS-107	207
6 BSS-108	208

Spinal, 8"



Volkmann Currett,
Double Ended
BSV-100 Small
BSV-200 Medium
BSV-300 Large



Cobb, 13"
10mm SPE-100, Small
15mm SPE-200, Medium
20mm SPE-300, Large



Lambotte 8"
ELE-01010mm
ELE-01515mm
ELE-02020mm
ELE-02525mm

Bone Chisels, Gouges, Osteotomes

Chisels



Stille, 20cm
Straight

- 5mm CHS-105
- 6mm CHS-106
- 8mm CHS-108
- 10mm CHS-110
- 12mm CHS-112
- 15mm CHS-115
- 20mm CHS-120
- 25mm CHS-125
- 30mm CHS-130

Osteotomes



- 5mm OSS-105
- 6mm OSS-106
- 8mm OSS-108
- 10mm OSS-110
- 12mm OSS-112
- 15mm OSS-115
- 20mm OSS-120
- 25mm OSS-125
- 30mm OSS-130

Gouges



- 5mm GOS-105
- 6mm GOS-106
- 8mm GOS-108
- 10mm GOS-110
- 12mm GOS-112
- 15mm GOS-115
- 20mm GOS-120
- 25mm GOS-125
- 30mm GOS-130

Chisels



Stille, 20cm
Curved

- 6mm CHS-205
- 6mm CHS-206
- 8mm CHS-208
- 10mm CHS-210
- 12mm CHS-212
- 15mm CHS-215
- 20mm CHS-220
- 25mm CHS-225
- 30mm CHS-230

Osteotomes



- 5mm OSS-205
- 6mm OSS-206
- 8mm OSS-208
- 10mm OSS-210
- 12mm OSS-212
- 15mm OSS-215
- 20mm OSS-220
- 25mm OSS-225
- 30mm OSS-230

Gauges



- 5mm GOS-205
- 6mm GOS-206
- 8mm GOS-208
- 10mm GOS-210
- 12mm GOS-212
- 15mm GOS-215
- 20mm GOS-220
- 25mm GOS-225
- 30mm GOS-230



Bone File, Double Ended, 8 3/4"
BFS-200



Bayonet, 9 1/2"
BFB-100



Bone File, 10"
BFS-100



Bristow, 9"
GBE-100



Adson 6 3/4"



EAN-150



EAN-160



EAN-170



EAN-180

25mm

22mm

8mm

18mm



Hohmann 11"
HBL-125



Hohmann 11"
HBL-070



Hohmann 8 3/4"
HBL-040



Hohmann 9 1/2"
HBL-060

24mm



Hohmann 10 ¼"
HBL-275

35mm



Hohmann 11 ¼"
HBL-110

43mm



Hohmann 9 ½"
HBL-090

43mm



Hohmann 9 ½"
HBL-080

70mm



Hohmann 9 ½"
HBL-100



Lane, 10"
BHL-110



Mini Hohmann, 6 ¼"



6mm
HBL-020



8mm
HBL-030

Bone Reduction Forceps



Verbrugge

- 6" VBF-020
- 7 ½" VBF-022
- 9 ½" VBF-025
- 10 ¼" VBF-026
- 11" VBF-027



Reduction

- 5½" BRD-106
- 7" BRD-107
- 8" BRD-108
- 9" BRD-109

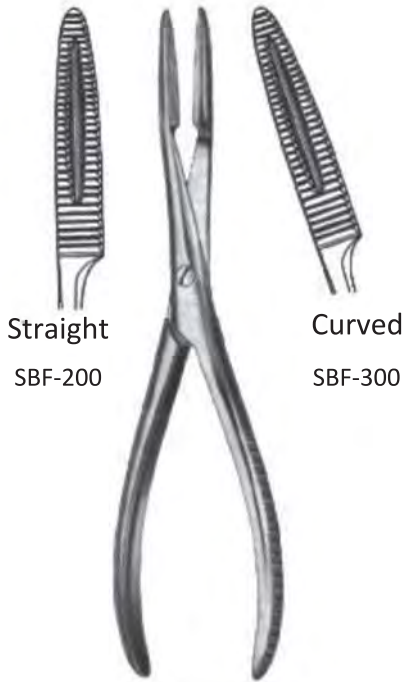

Straight
SBF-200

Curved
SBF-300

Sequestrum, 8"



Lane, 13"
BHL-113



4X4

Fergusson, 8 ¼"
BHF-305



- S HGF - 021
- M HGF - 029
- L HGF - 030

Hey grooves
HGF - 021

Bone Holding Forceps



Bone Reposition

- 5 3/4" BRE-006
- 6 1/4" BRE-116
- 8 3/4" BRE-117



Patella, 7"
BPF-207



Lowman

- 7" BHL-018
- 8" BHL-020
- 8 1/2" BHL-022



Smillie Minisectomy Knife, 6 3/4"
MSK - 100



Smillie Minisectomy Knife, 6 3/4"
MSK - 150



Smillie Minisectomy Knife, 6 3/4"
MSK - 200

Bone Rongeur Single Action



Jansen, 7"



BRS-105



BRS-205



Luer, 6"



2mm

BRC-502



3mm

BRC-602

8 mm



BRS-107

8 mm



BRS-209



Luer, 6 3/4"

10mm



BRS-108

10mm



BRS-210



Luer, 7 1/4"

Bone Rongeur Double Action



Echlin, 9"

- BRC-302-2mm
- BRC-303-3mm
- BRC-304-4mm
- BRC-306-6mm



Stillee Luer, 9"



BRC-110



BRC-210



Stillee-Ruskin, 9"



Straight

- BRC-102
- BRC-103
- BRC-104
- BRC-105
- BRC-106
- BRC-108

Curved

- BRC-202
- BRC-203
- BRC-204
- BRC-205
- BRC-206
- BRC-208



Bohler, 6"

4mm



BRC-160

4mm



BRC-260



4mm, Straight
BRC-111,

4mm, Curved
BRC-222

Beyer, 7"



Zaufal Jansen, 7"
BRC-221 5mm Curved



Beyer, 6"
BRC-011



2mm STR



Angled

Ruskin, 7"
BRC-275



6mm

Ruskin, 7"
BRC-175



Liston
Straight

- 6" BCS-106
- 7" BCS-107
- 8" BCS-108
- 9" BCS-109



Liston
Curved

- 6" BCS-206
- 7" BCS-207
- 8" BCS-208
- 9" BCS-209



Bohler, 6"

- 6" BCC-160
- 7" BCC-170



Straight



Angled



Mc Indoe, 7"

BCC-270



Ruskin-Liston, 7 1/2"



BCC-175



BCC-275



Stille-Liston

Straight Curved

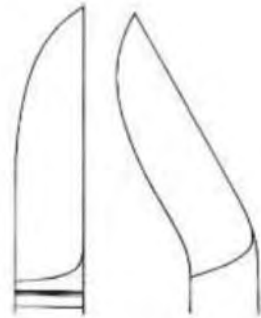

9" BCC-190	BCC-290
11" BCC-111	BCC-211



Tudor Edwards , 10 ½"
BCC-500

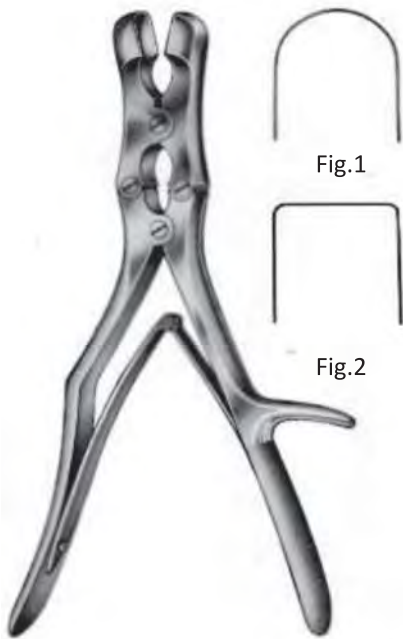

Sauerbruch, 12"
BCC-650, Fig.1
BCC-700 Fig.2



Giertz-Stille
BCC-600



Semp, 9 ½"
BCC-550



27 mm
140 gm

Cloward, 8 1/4"

MLT-400

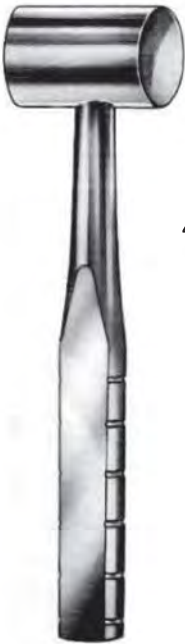

40 mm

Heath Mallet, 7"

MLT-500



Mallet, 9 1/2"

MLT-100-Small
MLT-200,Medium
MLT-300-Large



30 mm
215 gm

Mallet Teflon Head, 9 3/4"

MLT-900



230 gm

Mallet, 7 1/4"

MLT-001



150 gm

Cottle, 6 1/2"

CMH-185



McDonald (Jimmy)
DSM-100



Olivekrona, 7 1/2"
DSO-075



Olivekrona, 9 1/2"
DSO-095



Thyroid Dissector
KTE-101



Freer
FDE-185



Howarth
DSH-500



Pillar Retractor
TDR-200

Plaster Cutting Saw



Angel Saw
GAS-101



Finger Saw
GAS-102



Satterlee Saw
GAS-103



Henning Plaster Spreader, 11"
HPS-100



Plaster Cutter
HPS-150

Rochard Abdominal Retractor

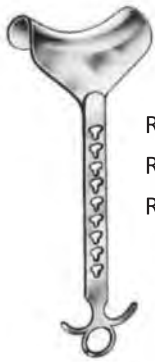

RDR-605 50x90mm
 RDR-606 50x105mm
 RDR-607 50x120mm



Mounting Frame

Table Cross Bar, 21"
 RDR-603



Fixation Device

Rochard
 RDR-005

Table Side Bar, 26"
 RDR-602

Rail Clamp
 RDR-601



RDR-600 Rochard Abdominal Retractor System, Consisting of;

RDR-601	Rail Clamp	-02nos
RDR-602	Table Side Bar, 26"(Mounting frame)	-02nos
RDR-603	Table Cross Bar, 21" (Mounting Frame)	-01nos
RDR-604	Rochard Fixation Device	-01nos
RDR-605	Rochard Abdominal Retractor 50 x 90mm	-01nos
RDR-606	Rochard Abdominal Retractor 50 x 105mm	-01nos
RDR-607	Rochard Abdominal Retractor 50 x 120mm	-01nos

Liver Transplant Retractor

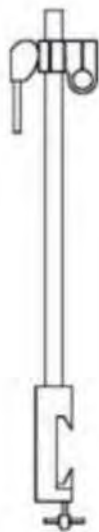

Sterile Post
fig 1



Cross Bar
fig 2

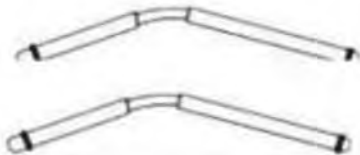

Angled Bar
fig 3

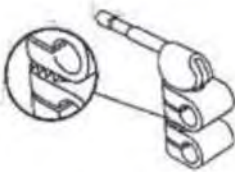

Cam Joint 1/2" x 1/2"
Cam Joint 1/2" x 1/4"
fig 4



Locking Handle
fig 5



Richardson Blade



Fence Blades



Balfour Center Blade



St. Mark's Pelvic Blade



Malleable Blades



Harrington Blade



Deavers Blades-Non Malleable



Malleable Finger Blade

Table Mounted Retractor System For Liver Procedures

DESCRIPTION	QTY
Sterile Post	1 No
Cross Bar	1 No
Angled Bar	2 No's
Cam Joint ½"x½"	3 No's
Cam Joint ½"x¼"	6 No's
Blade Handle 11"	6 No's
Malleable Blade 1"x8"	1 No
Malleable Blade 2"x8"	1 No
Harrington Blade 2 ½"x6"	1 No
Deaver's Blade-Non Malleable 1 ½"x5"	1 No
Deaver's Blade-Non Malleable 2"x5"	1 No
St.Mark's Pelvic Blade	1 No
Richardson Blade 2"x4"	1 No
Richardson Blade 2"x5"	1 No
Balfour Central Blade	2 No's

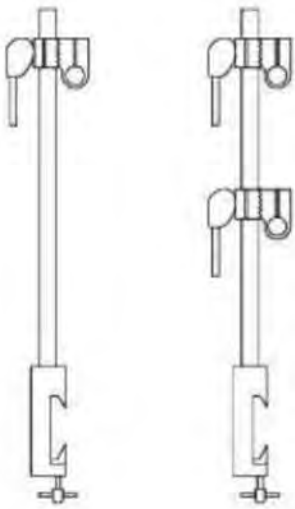

Sterile Post
fig 1



Cross Bar Biolater
fig 2

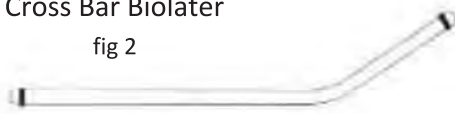

Cross Bar
fig 3

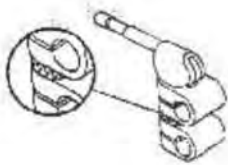

Cam Joint 1/2" x 1/2"
Cam Joint 1/2" x 1/4"
fig 4



Locking Handle
fig 5

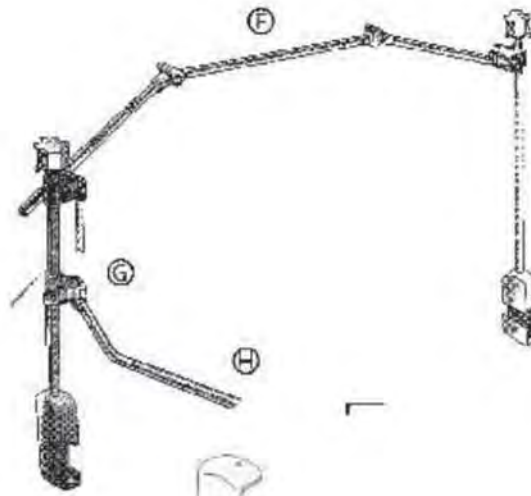

Richardson Blade

Fence Blades



Balfour Center Blade



St. Mark's Pelvic Blade



Malleable Blades



Harrington Blade



Deavers Blades-Non Malleable



Malleable Single Blade

Genetic “Modified” Bilateral Liver Transplant Retractor System

Description	Qty
Sterile Post	2 No's
Crossbar 18"	1 No
Crossbar Bilateral	1 No
Cam Joint ½"x½"	3 No's
Cam Joint ½"x¼"	6 No's
Interchangeable Locking Handle 11"	5 No's
Interchangeable Malleable Blade 1"x8"	1 No
Interchangeable malleable Blade 2"x8"	1 No
Interchangeable Balfour Blade 2.75"x3"	1 No
Interchangeable Richardson Blade 2"x4"	2 No's
Interchangeable Deaver Blade 1 ½"x5"	1 No
Interchangeable Deaver Blade 2"x5"	1 No
Interchangeable St.Mark's Blade 2 ½"x 7"	1 No
Interchangeable Malleable Finger Blade	1 No

Interchangable Blade



5cmx10cm (2"x4")
 5cmx12.5cm(2"x5")
 5cmx15cm(2"x6")

Richardson Blade



10cmx10cm
 10cmx12.5cm
 10cmx15cm
 10cmx20cm

Fence Blades



7cmx7.5cm(2.5"x3")
 8cmx7cm(
 8.8cmx8.8cm

Balfour Center Blade



6.2cmx17.6cm
 6.2cmx13.8cm

St.Mark's Pelvic Blade



2.5cmx10cm(1"x4")
 2.5cmx20cm(1"x8")
 3.8cmx20cm(1.5"x8")
 5cmx10cm(2"x4")
 5cmx20cm(2"x8")
 6.4cmx25cm(2.5"x10")
 7.6cmx25cm(
 10cmx25cm

Malleable Blades

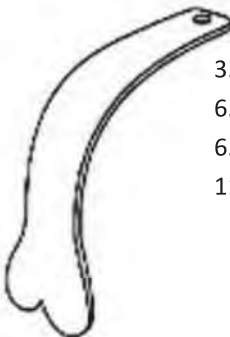

3.8cmx12.5cm
 6.4cmx15cm
 6.4cmx25cm
 11.4cmx25cm

Harrington Blade



2.5cmx5cm
 5cmx5cm
 2.5cmx12.5cm
 3.8cmx12.5cm
 5cmx12.5cm
 6.4cmx12.5cm

Deavers Blades-Non Malleable



15cm

Malleable Single Blade

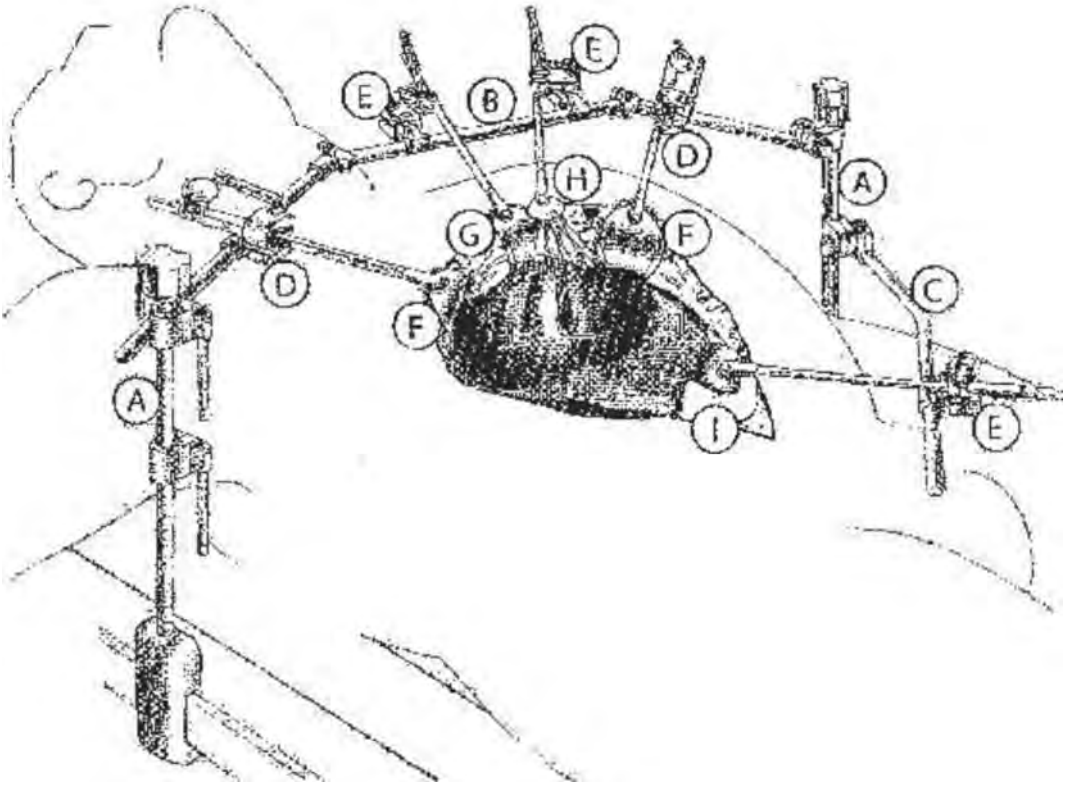
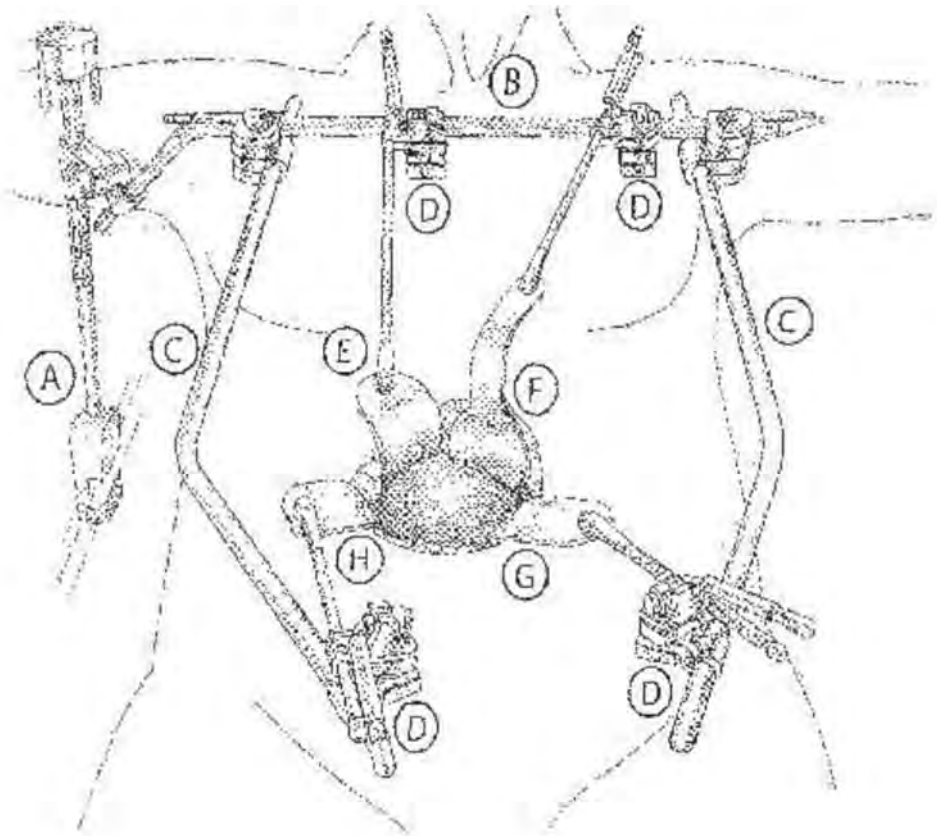

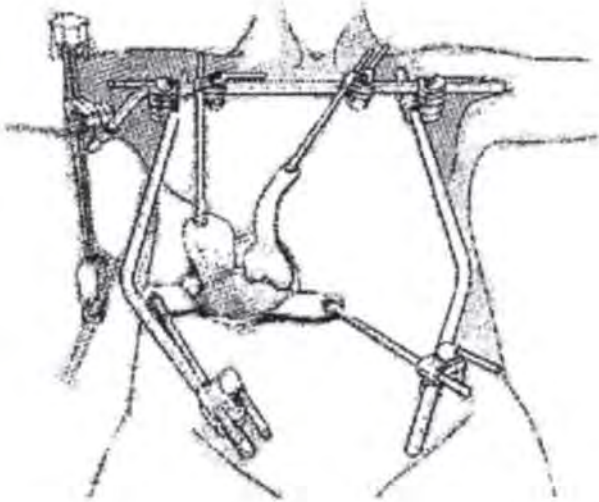

Liver- Single Post

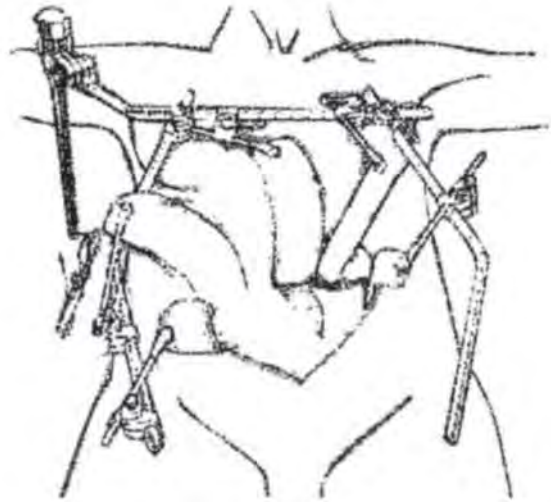

Liver - Double Post

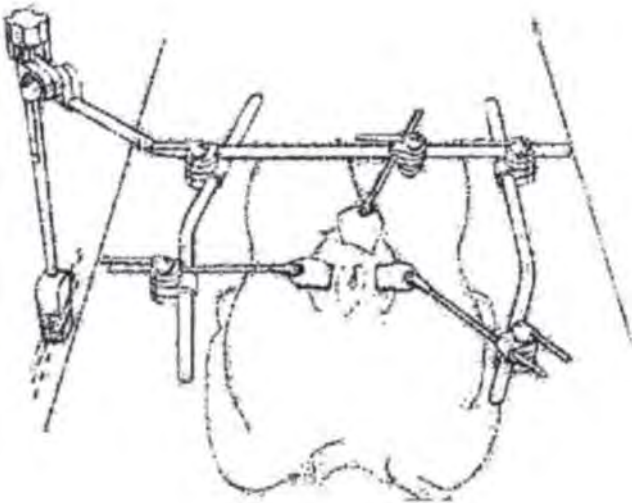

Pancreas - Single Post

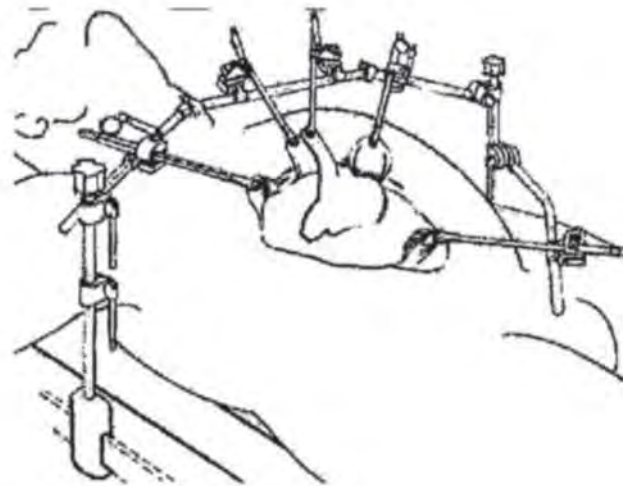

Liver & Gall Bladder - Double Post

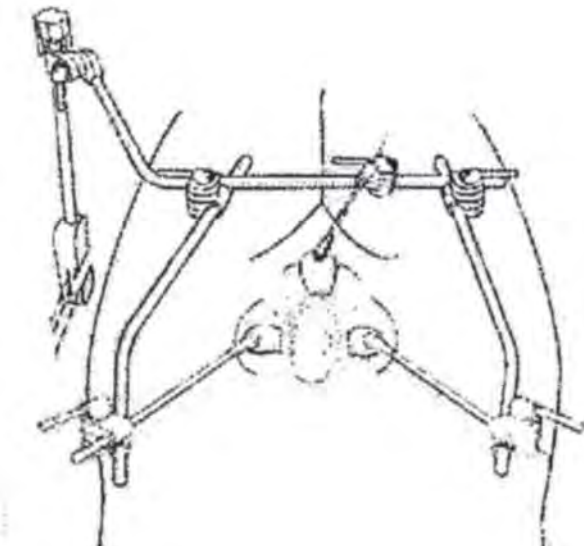

AAA - Single Post

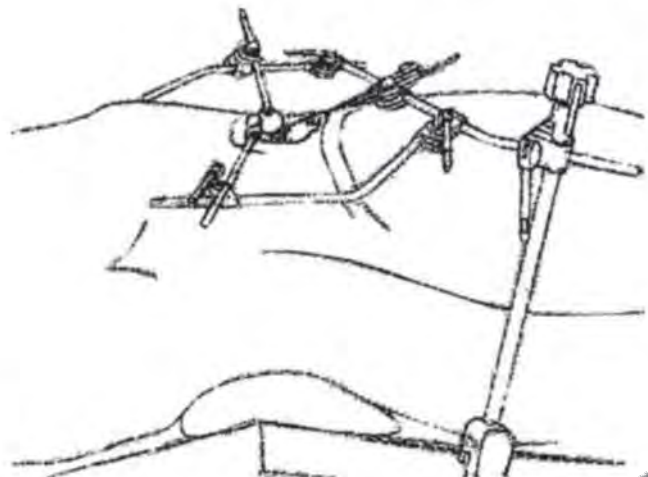

Kidney - Single Post

BOOK WALTER TYPE, RETRACTOR SYSTEM

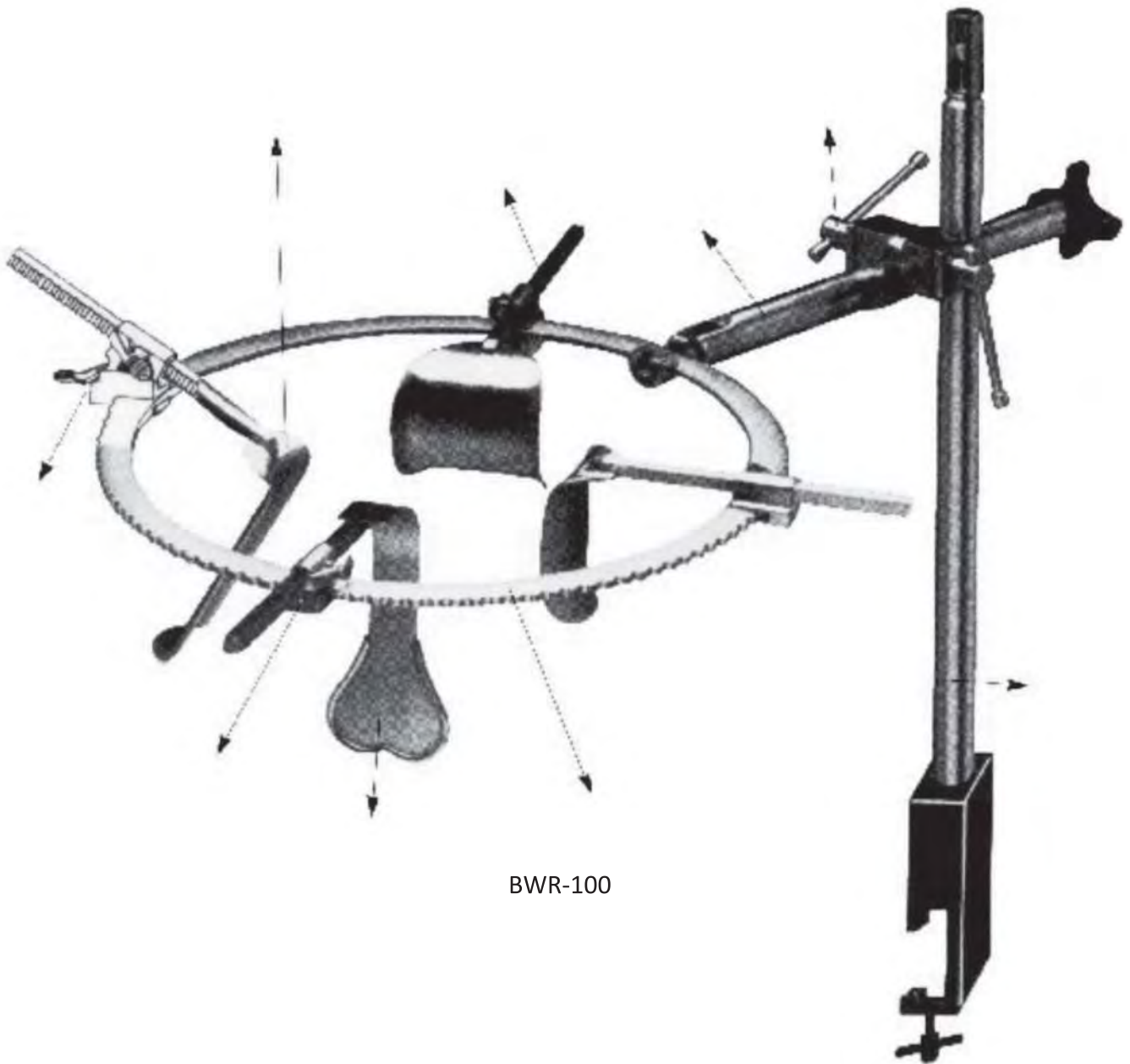

BWR-100

BOOK WALTER TYPE, RETRACTOR SYSTEM

DESCRIPTION	QTY
Table Post	1 No
Post Coupling	1 No
Horizontal Bar	1 No
Horizontal Flex Bar 360° Rotation	1 No
Small OVAL Ring 20cmx30cm	1 No
Medium OVAL Ring 27cmx37cm	1 No
Large OVAL Ring 27cm x 47cm	1 No
Small SEGMENTED Ring 21cm x 35cm	1 No
Medium SEGMENTED Ring 27cm x 49.05cm	1 No
Large SEGMENTED Ring 31cm x 49.5cm	1 No
Ratchet Mechanisms	4 No's
Tilt Ratchet Mechanisms	5 No's
Malleable Retractor Blade 51mm x 152mm	2 No's
Malleable Retractor Blade 38mm x 152mm	2 No's
Malleable Retractor Blade 76mm x 152mm	2 No's
Harrington Retractor Blade	1 No
Kelly Retractor Blade 51mm x 76mm	1 No
Kelly Retractor Blade 51mm x 102mm	1 No
Kelly Retractor Blade 51mm x 127mm	1 No
Kelly Retractor Blade 51mm x 152mm	1 No
Balfour Retractor Blade	1 No
Gelpi Retractor Blade	1 No



Oval Ring
Small 20cm x 30cm
Medium 27cm x 37cm
Large 27cm x 47cm



Segment Ring
Small 21cm x 35cm
Medium 27cm x 49.5
Large 31cm x 49.5cm



Table Post



Horizontal Flex bar



Horizontal Bar



Tilt Ratchet Mechanism



Post Coupling



Ratchet Mechanism



Kelly Retractor Blade

- 51mm x 76mm
- 51mm x 102mm
- 51mm x 127mm
- 51mm x 152 mm



Balfour Blade

67mm x 76mm



Gelpi Blade Retractor



Malleable Retractor Blade

- 38mm x 152mm
- 51mm x 152mm
- 76mm x 152mm



Harrington Blade

63mm x 143 mm

UPPER ABDOMINAL RETRACTOR SYSTEM



OMNI Retractor Kit With 7 Blades Consisting of

DESCRIPTION	QTY
Streile Field Post, Double Joint	2 Nos
Standard Cross Bar	1 No
Hinged Cross Bar	1 no
Snap Clamp Holder	7 Nos
Angled Side Arm 8" x 18"	2 Nos
Harrington Retractor Blade 5 ½ x 3 ½"	1 No
Sternal Retractor 3" x 3"	2 Nos
Mayo Swivel Retractor 3 ½" x 2 ¾"	2 Nos
Malleable Swivel Retractor 2" x 6 ½"	1 No
Malleable Swivel 3" x 6 ½"	1 No
Blade Holder 9"	1 No



MIS - 450 with lock
MIS - 400 without lock



MIS - 300
Rubinson Cannula



MIS - 022
Female Metal
Catheter

ALPHABETIC INDEX

Adenoid Curette	61	Catheter Introducer.....	34
Adson Dissecting Forceps	20	Chiropody Packer And Probe	
Adson Raspatory.....	66	Double Ended, 14.5Cm	45
Alexander Rib Raspatory.....	45	Chiropody Scraper With Flat Hollow	
Allis Tissue Forceps	15	Spoon, 13Cm	45
Allison Lung Retractor	52	Chiropody Scrapper With Flat	
Aim Self Retaining Retractor	27	Spoon, 13 Cm	45
Anderson Adson S/R Retractor	28	Chiropody Spatula And	
Artery Forceps.....	13	Packer Double Ended,14.5 Cm	45
Aural Dressing Forceps	62	Chiropody Spatula And	
Auwards Speculam.....	40	Probe Double Ended, 14.5Cm	45
B.P.Handle.....	1	Cloward Mallet	76
B.P.Handle No.SL.....	1	Glutton's Urethral Dilator	34
Babcock Tissue Forceps	15	Cobbs,Sj3inal Elevator.....	64
Baby Balfour Abdominal S/R Retractor.....	32	Collin Abdominal S/R Retractor.....	31
Baby Metzenbanum Scissors	3	Collin Lung Grasping Forceps	50
Backhaus Towel Clip	16	Cone's S/R Retractor	28
Backhaus Towel Clip	17	Converse Needle Holder.....	11
Bailey Rib Contractor	50	Cooley Mitral Valve Retractor.....	52
Bakes Common Bile Duct Dilator's	45	Cottle Mallet.....	76
Balanger Swival Knife	61	Crafoord Forceps.....	17
Baumgarten WireTwister.....	53	Crilewood Needle Holder.....	10
Bayonet Dissecting Forceps	19	Cross Action Towel Clip	16
Beckmann Adson S/R Retractor	29	Cusco's Speculams.....	40
Beckmann Eaton S/R Retractor	30	Gushing Dissecting Forceps	18
Berry Sternal Needle Holder.....	53	Cutical Nipper, Plier Handle, 10 Cm	45
Beyer Bone Rongeur.....	73	Cutical Nipper With Ring Handle, 10 Cm ..	45
Bilateral Liver transplant Retractor System	84	Cutical Scissors	3
Bilateral Retractor Blades	83	Czerny Retractor Double Ended	24
Blake Bladder Retractor	34	Dandy Side Curved Artery Forceps	14
Bohler Bone.....	74	Davidson Scapula Retractor	52
Bone File.....	66	Davis Boyles Mouth Gag	60
Bone Reduction Forceps	69	Deavers Retractor	26
Bone Reposition Forceps	70	Debakey Aortic Aneurysm Clamp	59
Bonneys Dissecting Forceps	19	Debakey Bulldog Clamp	54
Book Walter Tyre Retractor system	88	Debakey Derra Anastomosis Clamp	56
Bozemann Needle Holder	12	Debakey Diss,& Ligature Forceps	50
Brawn Episiotomy Scissors	4	Debakey Needle Holder	11
Bristow Periosteal Elevator	66	Debakey Renal Glover	
Brodie Probe Point.....	46	Anastomosis Clamp	58
Burford Finochitto Rib Spreader	49	Debakey Rib Spreader	49
Cannula.....	93	Debakey Ring Handle Bulldog Clamp	55
Castroviejo Needle Holder	12	Debakey Satinsky Venacava Clamp	57

Debakey Tangential Occulusion Clamp	58	Henning Plaster Spreader.....	78
Debakey Vascular Dissecting Forceps	54	Heparin (Vein) Cannula	47
Dennis Browne Abdominal Ring Retractor	33	Hernia Ring Forceps, 5 ^2"	35
Derf Needle Holder	10	Hey Grooves Retrogarde Bougies	69
Derf Needle Holder	11	Hohmann Bone Lever	67
Derra Cooley Anastomosis Clamp	56	Hook Retractor, Three Prongs	21
Desjardins Gall Stone Forceps	39	Howarth Dissector.....	77
Desmarres Eyelid Retractor.....	24	Interchangeable Blade.....	85
Dingmann Mouth Gag.....	60	Iris Scissors.....	3
Dissecting Forceps.....	18	Jacobson Micro Needle Holder Round	
Double Hook Retractor.....	21	Handle with Lock	12
Doyen Costotome.....	75	Jamison Scissors	5
Doyen Intestinal Clamp	36	Jansen Bone Rongeur.....	70
Doyen Mouth Gag.....	60	Jansen Mastoid S/R Retractor.....	27
Doyen Myoma Screw.....	41	. Jewellers Forceps	20
Doyen Rib Raspatory.....	51	Jobson Horn Probes	46
Doyens Retractor.....	22	Jolls Thyroid Retractor (Twin Clamp)	44
Doyens Wall Retractor.....	40	Kelly Retractor.....	22
Dressing Scissors.....	2	Kelly's Artery Forceps	13
Duval Lung Grasping Forceps	50	Killian Nasal Speculam	63
Echlin Bone Rongeur.....	72	Kocher Artery Forceps	15
Farabeuf Rib Raspatory.....	51	Kocher Bone Hook Retractor.....	23
Fergusson Bone Holding Forceps	69	Kocher Intestinal Clamp	37
Fergusson Mouth Gag.....	63	Kocher Thyroid Dissector.....	77
Finochitto Rib Spreader	48	Lachrymal Probe	46
Frazier Dural Scissors	5	Lahey'S Right Angle Forceps	16
Freer Elevator Double Ended	77	Lambotte Raspatory.....	64
Gelpi S/R Retractor.....	27	Lane Bone Holding Forceps	68
Gerald Dissecting Forceps	19	Lane's Intestinal Twin Clamp	39
Gietrz Rib Shear	75	Lane's Tissue Forceps	16
Gillies Skin Hook	21	Langenback Green (Pole) Retractor	21
Gillies Dissecting Forceps	18	Langenback Retractor.....	25
Gillies Scissors Cum Needle Holder	10	Langenback Rib Raspatory.....	53
Cosset Abdominal S/R Retractor	31	Lees (Debakey) Bronchus Clamp	58
Green Armytage Forceps	43	Listers Bandage Cutting Scissors	4
Halsey Needle Holder.....	10	Lister's Sinus Forceps	17
Hardy Pituitary Spoon	78	Listen Bone Cutter	74
Harken Veancava Clamp	59	Listen Bone Cutter.....	75
Harrington Retractor Flexible	26	Littauer Ligature Scissors	4
Heany's Hysterectomy Clamp	17	Liver transplantation.....	81
Heath Suture Removal Scissors 6"	3	Lockhart-Mummery Fistula Probe	46
Heggar'S Dilator.....	42	Lowmann Bone Holding Clamp	70
Henley Self Retaining Retractor.....	30		

Luc's Nasal Tarbinate Forceps	62	Nerve Hook	45
Luer Bone Rongeur.....	71	North Field (Stille Luer) Bone Rongeur.....	72
Magils Forceps.....	62	Noto Polypus Forceps	43
Mallet.....	76	Novak Endometrial Curette	41
Malliable Probe.....	46	Olivekrona Dissector Double Ended	77
Malliable Spatula.....	25	OMNI Retractor Kit.....	93
Mastoid (Mollison) Self Retaining Retractor	28	Parker Langenback Retractor	22
Mayo Hegggar Needle Holder	10	Parks Anal Self Retaining Retractor	42
Mayo Hegggar Needle Holder, With		Patella Bare Holding Forceps	70
'Imported' Tungsten Carbide	11	Payrs Intestinal Crushing Clamp	37
Mayo Russian Dissecting Forceps	19	Plester Self Retaining Retractor	27
Mayo Scissors.....	6	13 Chiropody Instruments	45
Mayo's Safety.....	62	Pools Abdominal Suction Tip	38
Mcindoe Bone Cutter	74	: Potts Scissors	9
Mcindoe Dissecting Forceps	18	Potts Vascular Scissors	8
Metzenbaum Scissors.....	7	, Pozzis Abdominal S/R Retractor	31
Meyerding Finger Retractor.....	25	Price Thomas Bronchus Clamp With Pins	59
Micro Mosquito Artery Forceps	13	PROTOSCOPE	35
Micro Suction Tip	38	Robberts Artery Forceps	14
Millin-Murray Outlet Forceps	42	Rochard Abdominal Retractor	79
Millins Bladder S/R Retractor.....	34	Ross Aortic Retractor	52
Mini-Langenbeck Retractor.....	21	Roux ("C" Loop) Retractor	22
Miskimon Cerebellar Self Retaining		Rubio Wire Twister	53
Retractor	30	Ruskin Bone Rongeur	72
Mixture Right Angle Forceps	16	Ryder Needle Holder	12
Morris Retractor.....	22	Sauer Bruch Cutter	75
Morse Sternal Retractor.....	48	Schmid Irrigation Cannula	47
Mosquito Artery Forceps	13	Schumaker Punch Biopsy Forceps	41
Museux Uterine Elevating Forceps	43	Semb Cutter	75
Myerding Laminectomy S/R Retractor	29	Semb Ligature Carrier Clamp	57
Myocardial (Cow Horn) Dilator	45	Semb Rib Raspatory	51
Nabatuff Veins Strippers	47	Senn-Muller (Cats Paw) Retractor	21
Nail Nipper With Barreal Spring,		Sequstrum Bone Holding Forecps	69
Concave Edges,13Cm	45	Shop Scissor	4
Nail Nipper With Spring Lock,		Simpson Outlet Forceps	42
Concave Edges, 14Cm	45	Sim's Speculams	40
Nail Nipper With Spring Lock,14 Cm	45	Sim's Uterine Sound	44
Nail Scissors, Curved, 9cm	45	Sim's Utrine Curette	44
Nail Scissors, Outside Serrated Blades,		Sim's Utrine Depressor	44
Straight, 10.SCm	45	Single Hook Retractor	21
Nail Splitter, Straight, 13Cm	45	Smillie Minisectomy Knife	70
Negus Tonsil Artery Forceps	17	Somers Uterine Holding Forceps	43
Nelson Lung Dissecting Forceps	19	Spencer- Wells Artery Forceps	14
Nelson Trocar.....	38		

Spinal Fushion Curette	64
Sponge Holding Forceps	15
St. Marks (Lloyd Davis) Pelvis Retractor ..	24
Stevens Tenetomy Scissors	5
Stille Chisel.....	65
Stille Gouge.....	65
Stille Osteotome.....	65
Suprapubic Trocar & Cannula.....	38
Table Mounted Retractor System For Liver Procedure	82
Teals Vulsellum Forceps	43
Tilles Nasal Dressing Forceps	62
Tongue Depressor.....	63
Tonsil Artery Forceps	14
Tonsil Dissector & Pillar Retractor	78
Tracheal Dilator.....	61
Travers Self Retaining Retractor	29
Trocar Cannula Set of four	38
Tube Cutting Scissors	4
Tubing Clamp.....	50
Tudor Edwards (Stille-Horsley) Bone Cutter	75
Tuffier Rib Spreader, Adult.....	49
Tuttle Lung Dissecting Forceps	19
Tylor Dural Scissors	5
U.S. Army Pattern Retractor Double - Ended	22
Umblical Cord Scissors	4
Upper Abdominal Retractor System	92
Utrine Tenaculam Forceps	43
Van-Buren Urethral Dilator's	34
Vandoren Cervical Punch Biopsy Forceps	41
Verbrugge Bone Holding Forceps	69
Volkman (Rake) Retractor	23
Volkman Bone Curette	64
Walshem Spectem Forceps	62
Waugh Dissecting Forceps	19
Webster Needle Holder	10
Weitlaner S/R Retractor	28
Wire Cutter.....	53
Wire Cutting Scissors	5
Wrigley Outlet Forceps	42
Yaunker Suction.....	38
Zaufal Jansen Bone Rongeur.....	73
Zenker Retractor.....	24

INDEX	PAGE NO	INDEX	PAGE NO	INDEX	PAGE NO	INDEX	PAGE NO	INDEX	PAGE NO
ABF-250	20	AFT-307	14	BPH-007	1	BSS-102	64	CHS-130	65
ADF-100	20	AFT-308	14	BPH-113	1	BSS-103	64	CHS-205	65
ADF-101	20	ASF-100	62	BPH-114	1	BSS-104	64	CHS-206	65
ADF-102	20	BCC-111	73	BPH-117	1	BSS-105	64	CHS-208	65
ADF-103	20	BCC-111	75	BRC-011	73	BSS-106	64	CHS-210	65
ADF-125	62	BCC-160	74	BRC-102	72	BSS-107	64	CHS-212	65
ADF-150	20	BCC-170	74	BRC-103	72	BSS-108	64	CHS-215	65
ADF-160	20	BCC-175	74	BRC-104	72	BSV-001	64	CHS-220	65
ADF-170	20	BCC-190	75	BRC-105	72	BSV-002	64	CHS-225	65
ADF-180	20	BCC-211	75	BRC-106	72	BSV-003	64	CHS-230	65
ADF-200	20	BCC-270	74	BRC-108	72	BSV-004	64	CIR-100	34
ADF-201	20	BCC-275	74	BRC-110	72	BSV-010	64	CIR-100	39
ADF-202	20	BCC-290	75	BRC-111	73	BSV-020	64	CIR-200	34
ADF-203	20	BCC-500	75	BRC-160	72	BSV-030	64	CIR-200	39
ADF-250	20	BCC-550	75	BRC-175	73	BSV-040	64	CMH-185	76
ADF-260	20	BCC-600	75	BRC-202	72	BSV-050	64	CMR-100	52
ADF-270	20	BCC-650	75	BRC-203	72	BSV-060	64	CMR-200	52
ADF-280	20	BCC-700	75	BRC-204	72	BSV-100	64	CMR-200	52
AFC-105	14	BCS-106	74	BRC-205	72	BSV-200	64	CMR-300	52
AFC-006	13	BCS-107	74	BRC-206	72	BSV-300	64	CPB-300	41
AFC-106	14	BCS-108	74	BRC-208	72	BWR-100	88	CVN-700	12
AFC-007	13	BCS-109	74	BRC-210	72	CDC-150	56	CVN-800	12
AFC-107	14	BCS-206	74	BRC-221	73	CDC-200	56	CVN-900	12
AFC-008	13	BCS-207	74	BRC-222	73	CDC-250	56	CVS-001	39
AFC-108	14	BCS-208	74	BRC-260	72	CDF-206	17	CVS-002	40
AFC-009	13	BCS-209	74	BRC-275	73	CDF-206	18	CVS-003	40
AFC-010	13	BDF-055	19	BRC-302	72	CDF-207	18	DAA-010	59
AFC-012	13	BDF-065	19	BRC-303	72	CDF-208	18	DAA-020	59
AFC-200	17	BDF-075	19	BRC-304	72	CDF-306	18	DAA-030	59
AFK-206	13	BDF-085	19	BRC-306	72	CDF-307	18	DAA-040	59
AFK-207	13	BDF-155	19	BRC-502	71	CDF-308	18	DAC-100	57
AFK-208	13	BDF-165	19	BRC-602	71	CEA-110	61	DAC-200	57
AFK-209	13	BDF-175	19	BRD-106	69	CEA-120	61	DAC-300	57
AFK-210	13	BDF-185	19	BRD-107	69	CEA-140	61	DAF-005	14
AFK-306	13	BFB-100	65	BRD-108	69	CEA-160	61	DAF-006	14
AFK-307	13	BFS-100	66	BRD-109	69	CEA-180	61	DBC-100	58
AFK-308	13	BFS-200	66	BRE-006	70	CEA-200	61	DBC-200	58
AFK-309	13	BGD-011	54	BRE-116	70	CHD-125	45	DBG-115	54
AFK-310	13	BGD-080	54	BRE-117	70	CHD-125	47	DBG-120	54
AFS-105	14	BGD-108	54	BRS-105	71	CHN-108	17	DBG-125	54
AFS-006	13	BGD-111	54	BRS-107	71	CHN-208	17	DBG-130	54
AFS-106	14	BGD-120	54	BRS-108	71	CHN-308	17	DBG-135	54
AFS-007	13	BGD-222	54	BRS-205	71	CHN-408	17	DBG-140	54
AFS-107	14	BHF-305	69	BRS-209	71	CHS-105	65	DBG-215	54
AFS-008	13	BHL-018	70	BRS-210	71	CHS-106	65	DBG-220	54
AFS-108	14	BHL-020	70	BRS-215	50	CHS-108	65	DBG-225	54
AFS-009	13	BHL-022	70	BRS-220	50	CHS-110	65	DBG-230	54
AFS-010	13	BHL-110	68	BSK-130	61	CHS-112	65	DBG-235	54
AFS-011	13	BHL-113	69	BSK-230	61	CHS-115	65	DBG-240	54
AFT-207	14	BPF-207	70	BSS-100	64	CHS-120	65	DDC-150	56
AFT-208	14	BPH-004	1	BSS-101	64	CHS-125	65	DDC-200	56

INDEX	PAGE NO	INDEX	PAGE NO	INDEX	PAGE NO	INDEX	PAGE NO	INDEX	PAGE NO
DDC-250	56	BPH-007L	1	ELE-025	64	GVD-100	45	KAF-508	15
DFB-080	19	DRB-550	34	ESR-910	51	GVD-150	45	KAF-509	15
DFB-180	19	DRB-550	45	ESR-912	51	GVD-200	45	KAF-510	15
DFP-005	18	DRC-200	34	ESR-913	51	GVD-250	45	KAF-605	15
DFP-005F	18	DRC-200	39	ESR-914	51	GVD-300	45	KAF-606	15
DFP-006	18	DRH-200	40	ESR-915	51	HBL-020	68	KAF-607	15
DFP-006F	18	DRH-200	42	FDE-185	77	HBL-030	68	KAF-608	15
DFP-007	18	DRH-400	42	FDS-145	5	HBL-040	67	KAF-609	15
DFP-007F	18	DRS-100	44	FDS-170	5	HBL-060	67	KAF-610	15
DFP-008	18	DRV-250	34	FMG-100	63	HBL-070	67	KTE-101	77
DFP-008F	18	DRV-250	39	FPL-001	46	HBL-080	68	LCS-100	57
DFP-009	18	DSC-100	57	FPL-002	46	HBL-090	68	LCS-200	57
DFP-009F	18	DSC-200	57	FPL-003	46	HBL-100	68	LNF-001	62
DFP-010	18	DSC-300	57	FPL-004	46	HBL-110	68	LNF-002	62
DFP-010F	18	DSH-500	77	GAF-500	43	HBL-125	67	LNF-003	62
DFP-012	18	DSM-100	77	GAS-101	78	HBL-275	68	LRA-100	52
DFP-012F	18	DSO-075	77	GAS-102	78	HGS-100s	21	LRA-110	52
DFT-005	18	DSO-095	77	GAS-103	78	HGS-101b	21	LRF-205	16
DFT-005F	18	DTO-001	58	GBE-100	66	HNE-100	45	LRF-206	16
DFT-006	18	DTO-002	58	GDF-005	18	HNE-200	45	LRF-207	16
DFT-006F	18	DTO-003	58	GDF-006	18	HPS-100	78	LRF-208	16
DFT-007	18	DTO-004	58	GDF-007	18	HPS-150	78	LRF-209	16
DFT-007F	18	DTO-005	58	GDF-008	18	ILC-060	37	LRF-210	16
DFT-008	18	DTT-101	46	GDF-070	19	ILC-080	37	LSF-165	17
DFT-008F	18	DTT-102	46	GDF-080	19	ILC-090	37	MAC-004	13
DFT-009	18	DVF-160	54	GDF-090	19	ILC-260	37	MAC-005	13
DFT-009F	18	DVF-180	54	GDF-180	19	ILC-280	37	MAC-035	13
DFT-010	18	DVF-195	54	GLP-004	46	ILC-290	37	MAS-004	13
DFT-010F	18	DVF-615	54	GOS-105	65	ILC-460	36	MAS-005	13
DFT-012	18	DVF-620	54	GOS-106	65	ILC-470	36	MAS-035	13
DFT-012F	18	DVF-628	54	GOS-108	65	ILC-480	36	MGD-100	60
DFW-006	19	DVF-715	54	GOS-110	65	ILC-495	36	MGD-125	60
DFW-007	19	DVF-720	54	GOS-112	65	ILC-560	36	MGD-150	60
DFW-008	19	DVF-728	54	GOS-115	65	ILC-570	36	MGD-333	60
DGA-042	58	DVF-815	54	GOS-120	65	ILC-580	36	MGD-444	60
DGA-052	58	DVF-820	54	GOS-125	65	ILC-595	36	MGD-555	60
DHC-100	59	DVF-828	54	GOS-130	65	ILP-100	37	MIS-015	35
DHC-200	59	DVF-915	54	GOS-205	65	ILP-200	37	MIS-016	35
DHC-300	59	DVF-920	54	GOS-206	65	ILP-300	37	MIS-017	35
DHC-400	59	DVF-928	54	GOS-208	65	ITC-100	39	MLT-001	76
DLF-170	50	EAN-150	66	GOS-210	65	ITC-200	39	MLT-100	76
DLF-180	50	EAN-160	66	GOS-212	65	JHP-180	46	MLT-200	76
DLF-225	50	EAN-170	66	GOS-215	65	JMF-112	20	MLT-300	76
DLF-290	50	EAN-180	66	GOS-220	65	JMF-113	20	MLT-400	76
DMS-150	41	EAR-100	45	GOS-225	65	JMF-115	20	MLT-500	76
DMS-180	41	EDR-100	51	GOS-230	65	JMF-215	20	MLT-900	76
DRB-050	39	EDR-200	51	GSF_020	39	JRN-700	12	MMA-050	13
DRB-050	55	EFR-100	51	GSF-001	39	JRN-800	12	MMA-060	13
DRB-100	55	EFR-200	51	GSF-002	39	JRN-900	12	MMA-070	13
DRB-115	55	ELB-100	51	GSF-003	39	KAF-505	15	MMA-080	13
DRB-150	55	ELE-010	64	GSF-004	39	KAF-506	15	MPS-025	9
DRB-200	55	ELE-015	64	GSF-020	34	KAF-507	15	MPS-045	9

INDEX	PAGE NO	INDEX	PAGE NO	INDEX	PAGE NO	INDEX	PAGE NO	INDEX	PAGE NO
MPS-060	9	ELE-020	64	OSS-230	65	RCL-007	22	RJT-300	44
MPS-090	9	NHD-505	11	PAC-100	59	RDE-200	24	RJT-300	44
MPS-125	9	NHD-506	11	PAR-100	35	RDE-201	24	RKR-500	21
MRF-105	16	NHD-507	11	PAR-200	35	RDE-202	24	RKR-600	21
MRF-106	16	NHD-508	11	PAR-500	35	RDE-203	24	RKY-100	22
MRF-107	16	NHD-509	11	HRF-125	35	RDE-204	24	RKY-200	22
MRF-108	16	NHD-510	11	PPF-100	43	RDE-205	24	RKY-300	22
MRF-109	16	NHD-512	11	PRM-006	46	RDE-206	24	RLB-001	21
MRF-110	16	NHG-200	10	PRM-008	46	RDE-207	24	RLB-002	21
MRF-800	19	NHH-013	11	PSS-025	9	RDE-208	24	RLB-003	21
MRF-950	19	NHH-105	10	PSS-045	9	RDE-209	24	RLB-004	21
MRR-006	25	NHM-105	10	PSS-060	9	RDE-210	24	RLB-006	21
MRR-008	25	NHM-106	10	PSS-090	9	RDH-200	21	RLB-007	21
MRR-010	25	NHM-107	10	PSS-125	9	RDH-201	21	RDH-300	21
MRR-012	25	NHM-108	10	PTS025	8	RDH-301	21	RLB-101	25
MRR-014	25	NHM-109	10	PTS 045	8	RDH-400	21	RLB-102	25
MRR-016	25	NHM-110	10	PTS 060	8	RDH-401	21	RLB-103	25
MRR-018	25	NHM-111	10	PTS 125	8	RDO-400	40	RLB-104	25
MRR-020	25	NHM-112	10	PTS 145	8	RDO-401	22	RLB-105	25
MRR-022	25	NHR-012	11	PTS 160	8	RDO-402	22	RLB-106	25
MRR-121	25	NHR-050	12	PTS 225	8	RDO-403	22	RLB-107	25
MRR-122	25	NHR-100	12	POD-100	45	RDO-500	40	RLB-108	25
MRR-123	25	NHR-200	12	POD-101	45	RDO-600	40	RLB-109	25
MRR-124	25	NHR-300	12	POD-102	45	RDR-005	79	RLB-120	25
MRR-125	25	NHR-400	12	POD-103	45	RDR-601	79	RLB-121	25
MRR-812	25	NHW-013	11	POD-104	45	RDR-602	79	RLB-131	25
MRR-814	25	NHW-105	10	POD-105	45	RDR-603	79	RMO-201	22
MRR-825	25	NSK-001	63	POD-106	45	RDR-605	79	RMO-202	22
MRR-834	25	NSK-002	63	POD-107	45	RDR-606	79	RMO-203	22
MRR-835	25	NSK-003	63	POD-108	45	RDR-607	79	RPL-100	22
MSF-060	62	NSK-004	63	POD-109	45	RDS-500	52	RRK-202	23
MSF-080	62	NVS-100	47	POD-110	45	RDS-600	52	RRK-203	23
MSF-110	62	OLF-100	42	POD-111	45	RDV-127	26	RRK-204	23
MSK-100	70	OLF-101	42	POD-112	45	RDV-128	26	RRK-205	23
MSK-150	70	OLF-102	42	RAF-407	14	RDV-200	26	RRK-206	23
MSK-200	70	OSS-105	65	RAF-408	14	RDV-201	26	RRK-302	23
MSP-060	62	OSS-106	65	RAF-409	14	RDV-202	26	RRK-303	23
MSP-080	62	OSS-108	65	RAF-507	14	RDV-203	26	RRK-304	23
MSP-110	62	OSS-110	65	RAF-508	14	RDV-204	26	RRK-305	23
MVF-100	43	OSS-112	65	RAF-509	14	RDV-301	26	RRK-306	23
NDF-009	19	OSS-115	65	RAR-100	52	RDV-302	26	RSD-106	49
NHB-100	53	OSS-120	65	RAR-101	52	RDV-303	26	RSD-110	49
NHB-608	12	OSS-125	65	RAR-102	52	RDV-304	26	RSF-100	48
NHC-015	11	OSS-130	65	RBF-150	49	RDV-305	26	RSF-200	48
NHC-205	10	OSS-205	65	RBH-100	23	RDV-306	26	RSF-300	48
NHC-206	10	OSS-206	65	RBH-101	23	RDV-307	26	RSF-400	48
NHC-207	10	OSS-208	65	RBH-102	23	RDV-311	26	RSF-500	48
NHC-208	10	OSS-210	65	RBH-200	23	RDV-312	26	RSH-100	21
NHC-209	10	OSS-212	65	RBH-201	23	RDV-313	26	RSH-101	21
NHC-210	10	OSS-215	65	RBH-202	23	RGB-003	69	RST-400	49
NHC-212	10	OSS-220	65	RCL-005	22	RHR-135	26	RUS-220	22
NHD-105	10	OSS-225	65	RCL-006	22	RHR-145	26	RZR-100	24

INDEX	PAGE NO	INDEX	PAGE NO	INDEX	PAGE NO	INDEX	PAGE NO	INDEX	PAGE NO
RZR-101	24	SMA-308	6	SRA-105	31	STY-405	5	TFB-110	15
RZR-102	24	SMA-309	6	SRA-110	31	SUC-222	44	TFB-115	15
RZR-103	24	SMA-310	6	SRA-120	31	SUC-300	44	TFB-116	15
SBC 100	4	SMA-405	6	SRA-125	32	SUD-260	44	TFB-117	15
SBC-600	4	SMA-406	6	SRA-202	33	SUM-001	38	TFB-118	15
SBC-800	4	SMA-407	6	SRA-300	33	SUM-002	38	TFL-206	16
SBF-200	69	SMA-408	6	SRA-555	33	SUM-003	38	TFL-207	16
SBF-300	69	SMA-409	6	SRA-600	33	SUM-004	38	TFL-208	16
SCC-400	3	SMA-410	6	SRB-100	34	SUM-005	38	TNF-150	62
SCC-500	3	SMA-705	6	SRM-100	27	SUP-150	38	TOD-145	63
SCU-514	4	SMA-706	6	SRM-101	27	SUP-160	38	TOD-155	63
SDR-105	2	SMA-707	6	SRM-102	27	SUP-250	38	TOD-165	63
SDR-106	2	SMA-708	6	SRM-200	30	SUP-260	38	TRT-040	61
SDR-107	2	SMA-709	6	SRR-204	32	SUY-001	38	TRT-050	61
SDR-108	2	SMA-710	6	SRR-205	28	SUY-002	38	TRT-060	61
SDR-205	2	SMA-805	6	SRR-206	28	SVS-100	40	TSU-060	38
SDR-206	2	SMA-806	6	SRR-207	28	SVS-110	40	TSU-080	38
SDR-207	2	SMA-807	6	SRR-208	28	SVS-120	40	TSU-100	38
SDR-208	2	SMA-808	6	SRR-209	28	SVS-130	40	TVF-207	43
SDR-305	2	SMA-809	6	SRR-210	28	SVS-200	40	TVF-208	43
SDR-306	2	SMA-810	6	SRR-222	30	SVS-300	40	TVF-209	43
SDR-307	2	SMZ-103	3	SRR-305	28	SWC-100	5	TVF-210	43
SDR-308	2	SMZ-104	3	SRR-306	28	SWC-200	5	UCN-125	41
SDR-405	2	SMZ-105	7	SRR-307	28	TAF-800	17	UEF-900	43
SDR-406	2	SMZ-106	7	SRR-308	28	TAF-801	17	UTF-090	43
SDR-407	2	SMZ-107	7	SRR-309	28	TCB-915	17	UTF-100	43
SDR-408	2	SMZ-108	7	SRR-310	28	TBC-206	50	UTS-101	38
SDR-505	2	SMZ-109	7	SRR-315	28	TBC-208	50	VBF-020	69
SDR-506	2	SMZ-110	7	SRR-320	28	TBC-210	50	VBF-022	69
SDR-507	2	SMZ-205	7	SRR-400	29	TBC-306	50	VBF-025	69
SDR-508	2	SMZ-206	7	SRR-405	28	TBC-308	50	VBF-026	69
SDR-605	2	SMZ-207	7	SRR-406	28	TBC-310	50	VBF-027	69
SDR-606	2	SMZ-208	7	SRR-407	28	TCB-305	16	VCA-100	47
SDR-607	2	SMZ-209	7	SRR-408	28	TCB-314	16	VGA-101	47
SDR-608	2	SMZ-210	7	SRR-409	28	TCB-315	16	VGA-103	47
SEP-200	4	SMZ-505	7	SRR-410	28	TCB-316	16	VGA- 104	47
SHF-606	15	SMZ-506	7	SRR-420	30	TCB-317	16	VGA- 10 5	47
SHF-608	15	SMZ-507	7	SRR-425	29	TCB-318	16	VGA-106	47
SHF-609	15	SMZ-508	7	SRR-440	29	TCC-100	16	VCB-250	41
SHF-610	15	SMZ-509	7	SRR-504	27	TCS-100	4	VSR-100	47
SIR-555	3	SMZ-510	7	SRR-505	27	TCS-101	4	VSS-600	40
SIR-666	3	SMZ-605	7	SRR-506	27	TDF-007	19	WCA-700	53
SSC-006	3	SMZ-606	7	SRR-508	27	TDF-008	19	WCS-103	53
SJN-405	5	SMZ-607	7	SRR-600	27	TDF-009	19	WSF-100	62
SJN-406	5	SMZ-608	7	SRR-601	27	TDR-200	77	WSF-101	62
SJN-407	5	SMZ-609	7	SRR-725	29	TFA-005	15	WTB-500	53
SJN-408	5	SMZ-610	64	SRT-825	29	TFA-006	15	WTB-750	53
SJN-505	5	SPE-100	64	SSM-155	48	SRA-130	32		
SJN-506	5	SPE-200	64	SSM-160	48	SRA-200	32		
SJN-507	5	SPE-300	24	SSM-170	48	SRA-201	32		
SJN-508	5	SPR-001	24	SSM-175	48	TFA-007	15		
SLC-500	4	SPR-002	24	SSM-180	48	TFA-008	15		
SMA-305	6	SPR-003	24	STC-555	38	TFA-009	14		
SMA-306	6	RCZ-100	24	STC-666	38	TFA-009	15		
SMA-307	6	SPR-004	31	STY-305	5	TFA-010	15		



Genetic

GENETIC INSTRUMENTS PVT LTD

Plot No.2, Sri Krishna Nagar, 3rd Street, Kolathur, Chennai - 600 099.
Ph: +91-44-26511506, 26511706, 26511806 | e-mail: genetic@geneticinstruments.com